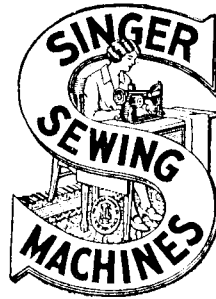


Form 18419
February, 1930
PRINTED IN U. S. A.

LIST OF PARTS



MACHINES

Nos. 147-30 and 147-31

THE SINGER MANUFACTURING COMPANY

COPYRIGHT, U. S. A.
1925, 1927, 1928, 1929 AND 1930
BY THE SINGER MANUFACTURING CO.
ALL RIGHTS RESERVED FOR ALL COUNTRIES

INDEX

| | PAGE |
|-----------------------------------|------|
| ACCESSORIES..... | 26 |
| BELT GUARD..... | 26 |
| BENCH STAND..... | 26 |
| FOOT LIFTER PARTS..... | 29 |
| FITTINGS FOR OVERALL WORK..... | 27 |
| " " HEAVY OVERALL WORK..... | 27 |
| " " SHIRT WORK..... | 28 |
| KNEE LIFTER PARTS..... | 29 |
| LAP SEAM FELLERS..... | 30 |
| MACHINE BASE..... | 30 |
| " No. 147-30..... | 7 |
| " " 147-31..... | 17 |
| NUMERICAL LIST OF PARTS..... | 33 |
| OBSOLETE PARTS..... | 31 |
| THREAD UNWINDER..... | 30 |

From the library of: Diamond Needle Corp

INSTRUCTIONS FOR ORDERING

In ordering from this list, use **ONLY** the part NUMBER in the **FIRST** column.

The number stamped on a Sewing Machine part is in every case the number of the single part only.

Every combination of parts sent out as such has its specific number, which, although not stamped on the parts, must be used when ordering the combination.

Each number always indicates the **SAME PART** in whatever list it appears, or for whatever machine.

The letters after some of the numbers indicate the style of finish only, as follows:

- A—Hardened, Polished, Nickel Plated and Buffed
- B—Polished, Nickel Plated and Buffed
- C—Hardened Only
- D—Polished Only
- E—Soft, Not Polished
- F—Hardened and Polished
- H—Blued
- J—Nickel Plated Only
- K—Hardened and Nickel Plated
- L—Brass Plated
- M—Oxidized
- N—Japanned, Dull
- P—Japanned, Bright
- R—Merlized
- T—Copper Plated
- T. A.—Hardened, Polished, Copper and Nickel Plated and Buffed.
- T. B.—Copper and Nickel Plated and Polished.
- T. J.—Copper and Nickel Plated Only.
- T. K.—Hardened, Copper and Nickel Plated.
- T. M.—Copper Plated and Oxidized.
- T. L.—Copper and Brass Plated.
- U—Zinc Plated
- V—Silver Plated
- W—Polished and Nickel Plated
- Z—Chromium Plated
- Z. B.—Polished, Nickel Plated, Buffed and Chromium Plated
- Z. J.—Nickel and Chromium Plated.

These letters **MUST BE USED** when they appear in the list; and **AFTER** the number **as** in the list.

In this series:

- 1 to 1500 and 50001 to 51500 are Screw Numbers
- 1501 to 1800 and 51501 to 51800 are Nut Numbers.
- 1801 to 2000 and 51801 to 52000 are Roller Numbers.
- 2001 to 50000 and 52001 and upward are numbers of Machine Parts.

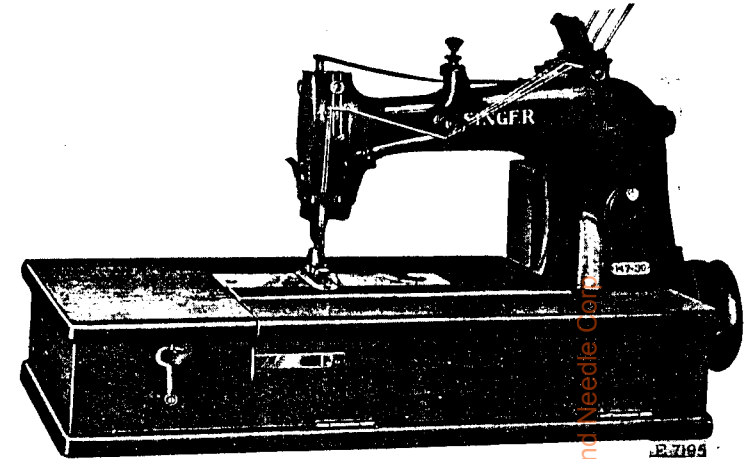
The figures in the second column refer only to the plates, illustrating the parts, and are **NOT TO BE USED** in ordering.

Parts marked with an asterisk (*) are furnished only when repairs are made at factory.

When ordering parts which differ as to **Gauge** (the distance between seams) the Gauge, as well as the **Number must be given** on order.

LIST OF PARTS COMPLETE

FOR



MACHINE No. 147-30

FOR GENERAL WORK IN FABRICS WHERE **THREE-LINE** STITCHING IS DESIRED. **THREE NEEDLES** AND **THREE LOOPERS**, FOR LAP SEAM FELLING. GAUGES FROM $\frac{3}{16}$ IN. TO $\frac{3}{16}$ IN. BETWEEN EACH NEEDLE. SPEED UP TO 3500, ACCORDING TO THE MATERIAL BEING STITCHED.

| NO. | PLATE | NAME |
|--------|-------|--|
| *54001 | — | Arm, upper and lower (solid) with 948D and 54034..... |
| 42366 | 8901 | Arm Oil Pad (braided cotton) for oiling Arm Rock Shaft Front Bearing..... |
| 56006 | 8901 | Arm Oil Pad (braided cotton) for oiling Arm Rock Shaft Intermediate Bearing. |
| 56003 | 8985 | Arm Oil Tube with 52045, for oiling 54326 |
| 52045 | 8901 | " " " Packing (braided cotton) .. |
| 54002 | 8902 | " Rock Shaft..... |
| 54079 | — | " " " 54002 with 54004, 54005 and 64255..... |
| 64386 | 8901 | Arm Rock Shaft Bushing (back)..... |
| 446c | 8901 | " " " " " Set Screw |
| 64388 | 8901 | " " " " " (intermediate) |
| 423c | 8901 | " " " " " " " |
| | | Set Screw..... |

From the Sewing Machine Needle Co.

| NO. | PLATE | NAME |
|--------|-------|---|
| 52045 | 8901 | Arm Rock Shaft Bushing Oil Pad (braided cotton)..... |
| 54004 | 8901 | Arm Rock Shaft Collar with two 453c... |
| 453c | 8901 | “ “ “ “ Set Screw..... |
| 54005 | 8901 | “ “ “ Crank (back) with two 50083c..... |
| 50083c | 8901 | Arm Rock Shaft Crank (back) Set Screw, |
| 64255 | 8911 | “ “ “ “ (front) with 453c |
| 2117 | 8901 | “ “ “ “ “ Pin..... |
| 453c | 8901 | “ “ “ “ “ Set Screw |
| 54105 | 8901 | “ “ “ Flanged Bushing (front) |
| 52045 | 8901 | “ “ “ “ “ “ Oil Pad (braided cotton)..... |
| 453c | 8901 | Arm Rock Shaft Flanged Bushing (front) Set Screw..... |
| *54006 | 9880 | Arm Rotary Shaft..... |

NOTE: When No. 54006 is required for repairs, the Loper Driving Shaft and Feed Lifting Eccentric must be returned to the factory to be adjusted to the new part.

| | | |
|--------|------|--|
| 54384 | — | Arm Rotary Shaft 54006 with 640b, 54008, 54088, 54113, 54383, 64351 and 64355. |
| 54367 | 8985 | Arm Rotary Shaft Bushing (front)..... |
| 52045 | 8901 | “ “ “ “ “ Oil Pad (braided cotton)..... |
| 51131E | 9872 | Arm Rotary Shaft Bushing (front) Set Screw..... |
| 54007 | 8902 | Arm Rotary Shaft Bushing (intermediate) |
| 54089 | — | “ “ “ “ “ “ 54007 with 64508 and 64805..... |
| 64508 | 8902 | Arm Rotary Shaft Bushing (intermediate) Oil Pad, long (braided cotton)..... |
| 64805 | 8985 | Arm Rotary Shaft Bushing (intermediate) Oil Pad, short (braided cotton)..... |
| 422c | 8901 | Arm Rotary Shaft Bushing (intermediate) Set Screw (long)..... |
| 50084c | 9872 | Arm Rotary Shaft Bushing (intermediate) Set Screw (short)..... |
| 54008 | 8901 | Arm Rotary Shaft Collar with three 1259c |
| 1259c | 8958 | “ “ “ “ “ Set Screw..... |
| 54009 | 8902 | “ “ “ Flanged Bushing..... |
| 54090 | — | “ “ “ “ “ “ 54009 with 58039 and 64805..... |
| 58039 | 8902 | Arm Rotary Shaft Flanged Bushing Oil Pad, long (braided cotton)..... |

| NO. | PLATE | NAME |
|--------|-------|--|
| 64805 | 8985 | Arm Rotary Shaft Flanged Bushing Oil Pad, short (braided cotton)..... |
| 159F | 8901 | Arm Rotary Shaft Flanged Bushing Screw |
| 49013 | 8904 | “ “ “ Front Bearing Oil Pad (braided cotton)..... |
| 144D | 8901 | Arm Rotary Shaft Screw..... |
| 15196 | 8902 | “ Side Cover (back)..... |
| 286D | 8904 | “ “ “ “ Thumb Screw... |
| 54010 | 8904 | “ “ “ (front)..... |
| 286D | 8904 | “ “ “ “ Thumb Screw... |
| 64259 | 9874 | Balance Wheel with two 430c..... |
| 430c | 8904 | “ “ Set Screw..... |
| 54011 | 9880 | Cloth Plate..... |
| 54012 | 8902 | “ “ Slide (left)..... |
| 38419 | 8904 | “ “ “ “ Spring..... |
| 725J | 8904 | “ “ “ “ “ Screw..... |
| 54013 | — | Cloth Plate Slide (left) complete, Nos. 38419, 54012, and two 725J..... |
| 54055 | 9874 | Cloth Plate Slide (right) for 54056..... |
| 54057 | 9874 | “ “ “ “ “ 54058..... |
| 38419 | 8904 | “ “ “ “ Spring..... |
| 725J | 8904 | “ “ “ “ “ Screw..... |
| 54056 | — | Cloth Plate Slide (right) complete for 54059, Nos. 38419, 54055 and two 725J |
| 54058 | — | Cloth Plate Slide (right) complete for 54060, Nos. 38419, 54057 and two 725J |
| 68192 | — | Cloth Plate Slide (right) complete for 68267, Nos. 38419, 68191 and two 725J |
| 54059 | — | Cloth Plate complete, for $\frac{3}{8}$ in. and $\frac{7}{16}$ in. gauges, for 68010, Nos. 54011, 54013 and 54056..... |
| 54060 | — | Cloth Plate complete, for $\frac{1}{8}$ in. and $\frac{9}{16}$ in. gauges, for 68010, Nos. 54011, 54013 and 54058..... |
| 68267 | — | Cloth Plate complete, for $\frac{5}{16}$ in. to $\frac{3}{8}$ in. gauges, for 68073, Nos. 54011, 54013 and 68192..... |
| 1011F | 8904 | Cloth Plate Screw (left)..... |
| 50473F | 8904 | “ “ “ (right)..... |
| 54104 | 9880 | “ “ Thread Guard..... |
| 1235D | 9872 | “ “ “ “ Screw..... |
| 54017 | 8902 | Crank Connecting Rod with 6575, 54018, 54218, 54897, 57222 and two each 896E and 1057E..... |
| 54088 | — | Crank Connecting Rod 54017 with 50069c |
| 50069c | 8904 | “ “ “ Ball Screw Stud |

| NO. | PLATE | NAME |
|--|-------|--|
| 1516E | 8904 | Crank Connecting Rod Ball Screw Stud Nut..... |
| 64268 | 8904 | Crank Connecting Rod Ball Screw Stud Nut Washer..... |
| *57222 | — | Crank Connecting Rod Cap (lower)..... |
| 896E | 8904 | " " " " " Screw |
| *54018 | — | " " " " " (upper)..... |
| 1057E | 8904 | " " " " " Screw |
| 54897 | 8904 | " " " " Oil Cup..... |
| 54218 | 8904 | " " " " " Pad (braided cotton)..... |
| 6575 | 8904 | Crank Connecting Rod Oil Pad Stop Pin |
| 54486 | 9874 | Face Plate..... |
| 46111 | 8911 | " " Pin..... |
| 286D | 8904 | " " Thumb Screw..... |
| 54487 | 9871 | " " Thread Guard..... |
| 236D | 9872 | " " " " " Screw..... |
| 54488 | 9874 | Feed Bar with 50429c and two 453c..... |
| 54020 | 8902 | " " Connection..... |
| 57225 | 8904 | " " Hinge Pin..... |
| 453C | 8901 | " " " " " Set Screw..... |
| 54111 | 8902 | " Connecting Rod with 1057E, 54112 and two 896E..... |
| 54113 | — | Feed Connecting Rod 54111 with 54025.. |
| *54112 | — | " " " Cap..... |
| 896E | 8904 | " " " " " Screw..... |
| 1057E | 8904 | " " " " " Clamping Screw... |
| 54023 | 8911 | " " " " " Hinge Pin..... |
| 21506 | 8904 | " " " " " Collar with 457c..... |
| 457C | 8904 | Feed Connecting Rod Hinge Pin Collar Set Screw..... |
| 54489 | 9875 | Feed Dog, 22 teeth (14 teeth to the inch) for 68010..... |
| 68072 | 9875 | Feed Dog, 14 teeth (19 teeth to the inch) for 68073..... |
| NOTE: When ordering No. 54489 or 68072 state gauge required. | | |
| 157W | 8904 | Feed Dog Screw..... |
| 50429C | 8904 | " " Stop Screw..... |
| *54024 | — | " Eccentric..... |
| *23729 | — | " " Body..... |
| 51061C | 8958 | " " " " " Set Screw..... |
| 7071 | 8904 | " " Clamping Washer..... |
| 217D | 8904 | " " " " " Screw.. |

| NO. | PLATE | NAME |
|---|-------|--|
| 54025 | 8985 | Feed Eccentric (adjustable) complete, Nos. 217D, 1103C, 7071, 23729, 54024 and two 51061C..... |
| 1103C | 8904 | Feed Regulating Screw..... |
| 54026 | 9873 | " " " " " " " Rocking Frame with two 453c..... |
| 68022 | — | " " " " " " " 54026 with 21506, 54020, 54023, 54488 and 57225..... |
| 57234 | 8911 | Feed Rocking Frame Hinge Pin..... |
| 57235 | 8985 | " " " " " " " Bushing |
| 453C | 8901 | " " " " " " " " Set Screw..... |
| 453C | 8901 | Feed Rocking Frame Hinge Pin Set Screw |
| 54490 | 9869 | Looper (back) closed eye..... |
| 1147C | 9872 | " " " " " Set Screw..... |
| 54491 | 9869 | " (front) closed eye..... |
| 229D | 8958 | " " " " " Screw (left)..... |
| 1302D | 9872 | " " " " " (right)..... |
| 54492 | 9869 | " (intermediate) closed eye..... |
| 68015 | — | " " " " " " " 54492 with 229D, 1302D and 54491..... |
| 1120C | 8958 | Looper (intermediate) Set Screw..... |
| 54027 | 9869 | " Carrier with two 171D..... |
| 171D | 8958 | " " " " " Adjusting Screw..... |
| 54227 | 9869 | " " " " " Connection..... |
| 54228 | 9869 | " " " " " Shaft..... |
| 54229 | 9876 | " " " " " " " Bushing |
| 446C | 8901 | " " " " " " " " Set Screw..... |
| 49013 | 8904 | Looper Carrier Connection Shaft Oil Pad (braided cotton)..... |
| 54230 | 9869 | Looper Carrier Driver with 54032 and four 175E..... |
| *54032 | — | Looper Carrier Driver Cap..... |
| 175E | 8958 | " " " " " " " Screw..... |
| *54368 | 8961 | " Driving Shaft and Feed Lifting Eccentric with 227D and two 64315.... |
| NOTE: When No. 54368 is required for repairs the Arm Rotary Shaft must be returned to the factory to be adjusted to the new part. | | |
| 54383 | — | Looper Driving Shaft and Feed Lifting Eccentric 54368 with 54027, 54227, 54228 and 54230..... |
| *54034 | — | Looper Driving Shaft and Feed Lifting Eccentric Bracket with 761E..... |
| 54080 | 9876 | Looper Driving Shaft and Feed Lifting Eccentric Bracket Bushing..... |

| NO. | PLATE | NAME |
|---|-------|--|
| 761E | 8901 | Looper Driving Shaft and Feed Lifting Eccentric Bracket Bushing Set Screw. |
| 948D | 8958 | Looper Driving Shaft and Feed Lifting Eccentric Bracket Screw. |
| 64315 | 9870 | Looper Driving Shaft and Feed Lifting Eccentric Bracket Oil Hole Plug. |
| 227D | 8958 | Looper Driving Shaft and Feed Lifting Eccentric Bracket Oil Hole Screw. |
| 40326 | 8961 | Looper Driving Shaft and Feed Lifting Eccentric Oil Pad (braided cotton). |
| 640D | 8958 | Looper Driving Shaft and Feed Lifting Eccentric Screw. |
| 54061 | 9869 | Looper Holder with 1120c and 1147c. |
| 704W | 8958 | " " Screw. |
| 68083 | 9871 | " Thread Guide. |
| 1698E | 9872 | " " " Nut. |
| 59456 | 9870 | " " " Washer. |
| 64319 | 9872 | Needle Bar (hollow). |
| 54493 | --- | Needle Bar complete, Nos. 64319 and 128215. |
| 38456 | 8961 | Needle Bar Bushing (lower). |
| 1133E | 8958 | " " " " Set Screw. |
| 64320 | 8961 | " " " (upper). |
| 1133E | 8958 | " " " " Set Screw. |
| 54326 | 8961 | " " Connecting Link. |
| 54329 | --- | " " " " 54326 with 54327 and 54328. |
| 54327 | 8961 | Needle Bar Connecting Link Hinge Stud |
| 1520J | 9872 | " " " " " " |
| | | Nut. |
| 54328 | 8961 | Needle Bar Connecting Stud with 211F and two 187E. |
| 187E | 8958 | Needle Bar Connecting Stud Screw. |
| 128215 | 9872 | " Clamp with three 1498E. |
| 54494 | 9872 | " Guard, for $\frac{3}{32}$ in. to $\frac{9}{16}$ in. gauges between each needle. |
| 68247 | --- | Needle Guard, for $\frac{5}{32}$ in. to $\frac{3}{16}$ in. gauges between each needle. |
| NOTE: When ordering No. 54494 or 68247 state gauge of machine for which required. | | |
| 54038 | 8961 | Needle Guard Holder. |
| 176D | 8958 | " " " Screw. |
| 217F | 8904 | " " " Screw. |
| 1498E | 9872 | " Set Screw. |
| 54108 | --- | Oil Tube. |
| 54109 | --- | " " Bracket. |

| NO. | PLATE | NAME |
|-------|-------|---|
| 49092 | 9870 | Oil Tube Packing (felt). |
| 54110 | 9870 | Oil Tube complete, for oiling Crank Connecting Rod (upper bearing) Nos. 49092, 54108 and 54109. |
| 64330 | 9873 | Presser Bar with 25303. |
| 25303 | 8961 | " " Ball, size $\frac{1}{4}$ in. |
| 64331 | 8911 | " " Bushing (lower). |
| 1133E | 8958 | " " " " Set Screw. |
| 38456 | 8961 | Presser Bar Bushing (upper). |
| 1133E | 8958 | " " " " Set Screw. |
| 54039 | 8985 | " " Guide Bracket with 453c, 640w and 1963. |
| 640W | 8958 | Presser Bar Guide Bracket Adjusting Screw. |
| 11173 | 8985 | Presser Bar Guide Bracket Guide. |
| 447C | 8958 | " " " " " Set Screw. |
| 1963 | 8985 | Presser Bar Guide Bracket Roller and Stud. |
| 453C | 8901 | Presser Bar Guide Bracket Set Screw. |
| 57257 | 8911 | " " Lifter. |
| 57258 | 8911 | " " " Hinge Pin. |
| 447C | 8958 | " " " " " Set Screw. |
| 1872 | 8985 | " " " Roller and Stud. |
| 1250C | 8911 | " " " Stop Screw. |
| 61047 | 8911 | " " Lifting Bracket with 460c and 1872. |
| 68208 | 9873 | Presser Bar Lifting Lever. |
| 61075 | 8911 | " " " " Connecting Stud. |
| 460C | 9872 | Presser Bar Lifting Lever Connecting Stud Set Screw. |
| 68184 | 9873 | Presser Bar Lifting Lever Extension. |
| 161D | 8958 | " " " " " Screw. |
| 802D | 8958 | " " " " Hinge Screw. |
| 54040 | 9873 | " " Spring (flat). |
| 38468 | 9872 | " " " Stud. |
| 26276 | 8911 | " Foot Hinge Pin. |
| 68202 | --- | " " Plate. |
| 46087 | --- | " " Shank. |
| 68203 | 9877 | Presser Foot (hinged) complete, for $\frac{3}{16}$ in. to $\frac{1}{16}$ in. gauges, Nos. 26276, 46087 and 68202. |
| 190D | 8958 | Presser Foot Screw. |
| 574W | 8958 | Pressure Regulating Thumb Screw. |
| 1539W | 9872 | " " " " Lock Nut. |

| NO. | PLATE | NAME |
|--------|-------|---|
| 51381 | 9870 | Slack Thread Controller..... |
| 51242 | 9870 | “ “ “ Clamp..... |
| 190b | 8958 | “ “ “ “ Screw.... |
| 54500 | 9870 | “ “ Regulator..... |
| 54042 | 9870 | “ “ “ Holder with 175E and two 50150c..... |
| 175E | 8958 | Slack Thread Regulator Holder Clamping Screw..... |
| 54043 | 9870 | Slack Thread Regulator Holder Shaft |
| 24292 | 9870 | “ “ “ “ “ |
| 1019c | 8958 | Slack Thread Regulator Holder Shaft Collar Set Screw..... |
| 54044 | 9870 | Slack Thread Regulator Holder Shaft Crank (forked) with 1253c..... |
| 1253c | — | Slack Thread Regulator Holder Shaft Crank Set Screw..... |
| 50150c | 8958 | Slack Thread Regulator Set Screw..... |
| 2102 | 8964 | Tension (under thread) Disc..... |
| 68001 | 9871 | “ “ “ Plate..... |
| 742F | 9872 | “ “ “ “ Screw.... |
| 51570c | 8964 | “ “ “ Regulating Thumb Nut..... |
| 50326c | 8964 | Tension (under thread) Screw Stud..... |
| 59539 | — | “ “ “ “ “ 50326c with 51570c..... |
| 59534 | 8964 | Tension (under thread) Spring..... |
| 59537 | 8964 | “ “ “ “ Bushing (large)..... |
| 59538 | 8964 | Tension (under thread) Spring Bushing (small)..... |
| 17547 | 8964 | Tension (under thread) Thread Guide... |
| 68002 | 9874 | “ (upper thread) Bracket..... |
| 376b | 8958 | “ “ “ “ Screw.... |
| 2102 | 8964 | “ “ “ Disc..... |
| 51570c | 8964 | “ “ “ Regulating Thumb Nut..... |
| 32572 | 8964 | Tension (upper thread) Releasing Disc... |
| 54988 | 8964 | “ “ “ “ Pin.... |
| 68003 | 9874 | “ “ “ “ Shaft |
| 54047 | 8964 | “ “ “ “ “ Crank with 624c..... |
| 54048 | 8964 | Tension (upper thread) Releasing Shaft Crank Link..... |
| 624c | 8958 | Tension (upper thread) Releasing Shaft Crank Set Screw..... |

| NO. | PLATE | NAME |
|--------|-------|--|
| 68261 | — | Tension (upper thread) Releasing Shaft Spring..... |
| 316F | 8958 | Tension (upper thread) Releasing Shaft Stop Screw..... |
| 1517J | 9872 | Tension (upper thread) Releasing Shaft Stop Screw Nut..... |
| 50326c | 8964 | Tension (upper thread) Screw Stud..... |
| 59539 | — | “ “ “ “ “ 50326c with 51570c..... |
| 59535 | 8964 | Tension (upper thread) Spring..... |
| 59537 | 8964 | “ “ “ “ Bushing (large)..... |
| 59538 | 8964 | Tension (upper thread) Spring Bushing (small)..... |
| 57076 | 8964 | Tension (upper thread) Thread Guide (double)..... |
| 68004 | 9871 | Thread (under) Eyelet (back)..... |
| 190b | 8958 | “ “ “ “ Screw.... |
| 68005 | 9871 | “ “ “ (front)..... |
| 64351 | 9870 | “ “ Nipper Cam with 465c |
| 465c | 8958 | “ “ “ “ Set Screw |
| 38210 | 9870 | “ “ “ Spring (lower). |
| 38211 | 9870 | “ “ “ “ (upper). |
| 46247 | 9870 | Thread (under) Nipper Spring (upper) Stop..... |
| 176b | 8958 | Thread (under) Nipper Spring Screw.... |
| 38475 | 9876 | “ “ Take-up with 465c.... |
| 465c | 8958 | “ “ “ Set Screw.... |
| 68165 | 9871 | “ “ “ Staple..... |
| 54049 | 9873 | “ “ “ “ Bracket with 460c..... |
| 965b | 9872 | Thread (under) Take-up Staple Bracket Screw..... |
| 46041 | 9871 | Thread (under) Take-up Staple Spring |
| 190b | 8958 | “ “ “ “ “ Screw..... |
| 38482 | 9871 | Thread (under) Take-up Stripper..... |
| 207b | 9872 | “ “ “ “ Screw.. |
| 64355 | 9871 | “ “ “ Thread Guard (brass)..... |
| 64356 | 9871 | Thread (under) Take-up Thread Guard Steady Pin..... |
| 460c | 9872 | Thread (under) Take-up Thread Guard Steady Pin Set Screw..... |
| 54330 | 9871 | Thread (upper) Controller..... |
| 207b | 9872 | “ “ “ Screw..... |

| NO. | PLATE | NAME |
|-------|-------|--|
| 68006 | 9871 | Thread (upper) Eyelet..... |
| 176D | 8958 | " " " Screw..... |
| 68007 | 9871 | " " " Take-up..... |
| 68008 | 9871 | " " " Plate..... |
| 68164 | 9871 | " " " " Spring |
| 1449D | 9872 | " " " " " |
| | | Screw..... |
| 68009 | — | Thread (upper) Take-up complete, Nos. 1449D, 68007, 68008 and 68164..... |
| 211F | 8958 | Thread (upper) Take-up Set Screw..... |
| 68010 | 9875 | Throat Plate, for 3/2 in. to 3/4 in. gauges, for 54489..... |
| 68073 | 9875 | Throat Plate, for 3/2 in. to 1/8 in. gauges, for 68072..... |

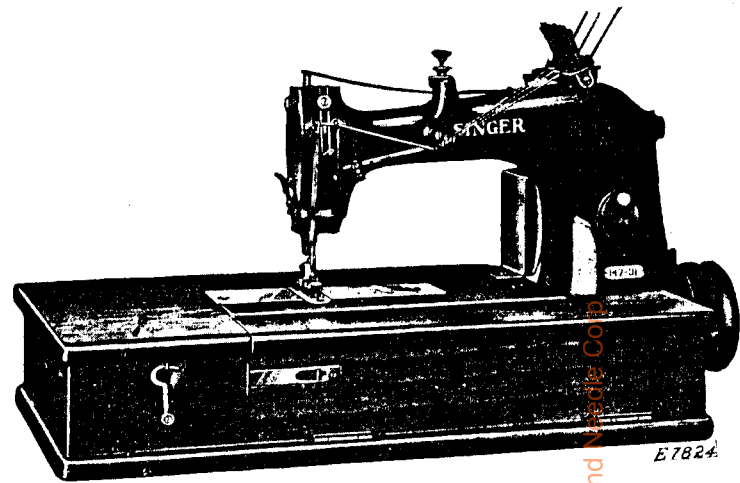
NOTE: When ordering Nos. 68010 or 68073, state gauge required.

| | | |
|------|------|-------------------------|
| 142F | 9872 | Throat Plate Screw..... |
|------|------|-------------------------|

Genuine Singer Needles and their Containers are marked with the Company's Trade Mark "SIMANCO." 1

Needles in Containers marked "For Singer Machines" are not Singer made needles. 2

LIST OF PARTS COMPLETE
FOR



MACHINE No. 147-31

FOR LAP SEAM FELLING ON OVERALLS AND WORK OF A SIMILAR NATURE. THREE NEEDLES AND THREE LOOPERS. GAUGES FROM 1/8 IN. TO 3/4 IN. BETWEEN EACH NEEDLE. LENGTH OF NEEDLE BAR STROKE 1 1/8 INCHES.

| NO. | PLATE | NAME |
|--------|-------|--|
| *68109 | — | Arm, upper and lower (solid) with 948D and 54034..... |
| 42366 | 8901 | Arm Oil Pad (braided cotton) for oiling Arm Rock Shaft Front Bearing..... |
| 56006 | 8901 | Arm Oil Pad (braided cotton) for oiling Arm Rock Shaft Intermediate Bearing..... |
| 56003 | 8985 | Arm Oil Tube with 52045, for oiling 54326 |
| 52045 | 8901 | " " " Packing (braided cotton)... |
| 54002 | 8902 | " Rock Shaft..... |
| 54079 | — | " " " 54002 with 54004, 54005, and 64255..... |
| 64386 | 8901 | Arm Rock Shaft Bushing (back)..... |
| 446c | 8901 | " " " " " Set Screw |
| 64388 | 8901 | " " " " (intermediate) |
| 423c | 8901 | " " " " " |
| | | Set Screw..... |

From the Firm the Diamond Needle Co.

| NO. | PLATE | NAME |
|--------|-------|---|
| 52045 | 8901 | Arm Rotary Shaft Bushing Oil Pad (braided cotton)..... |
| 54004 | 8901 | Arm Rotary Shaft Collar with two 453c... |
| 453c | 8901 | " " " " Set Screw..... |
| 54005 | 8901 | " " " " Crank (back) with two 50083c..... |
| 50083c | 8901 | Arm Rotary Shaft Crank (back) Set Screw..... |
| 64255 | 8911 | " " " " (front) with 453c..... |
| 2117 | 8901 | " " " " " Pin..... |
| 453c | 8901 | " " " " " Set Screw..... |
| 54105 | 8901 | " " " " Flanged Bushing (front)..... |
| 52045 | 8901 | " " " " " " Oil Pad (braided cotton)..... |
| 453c | 8901 | Arm Rotary Shaft Flanged Bushing (front) Set Screw..... |
| *68110 | 9880 | Arm Rotary Shaft..... |

Note: When No. 68110 is required for repairs, the Looper Driving Shaft and Feed Lifting Eccentric must be returned to the factory to be adjusted to the new part.

| | | |
|--------|------|--|
| 68111 | --- | Arm Rotary Shaft 68110 with 640b, 54008, 54088, 54113, 54383, 64351 and 64355. |
| 54367 | 8985 | Arm Rotary Shaft Bushing (front)..... |
| 52045 | 8901 | " " " " " " Oil Pad (braided cotton)..... |
| 51131E | 9872 | Arm Rotary Shaft Bushing (front) Set Screw..... |
| 54007 | 8902 | Arm Rotary Shaft Bushing (intermediate)..... |
| 54089 | --- | " " " " " " 54007 with 64508 and 64805..... |
| 64508 | 8902 | Arm Rotary Shaft Bushing (intermediate) Oil Pad, long (braided cotton)..... |
| 64805 | 8985 | Arm Rotary Shaft Bushing (intermediate) Oil Pad, short (braided cotton)..... |
| 422c | 8901 | Arm Rotary Shaft Bushing (intermediate) Set Screw (long)..... |
| 50084c | 9872 | Arm Rotary Shaft Bushing (intermediate) Set Screw (short)..... |
| 54008 | 8901 | Arm Rotary Shaft Collar with three 1259c..... |
| 1259c | 8958 | " " " " " " Set Screw..... |
| 54009 | 8902 | " " " " " " Flanged Bushing..... |
| 54090 | --- | " " " " " " 54009 with 58039 and 64805..... |
| 58039 | 8902 | Arm Rotary Shaft Flanged Bushing Oil Pad, long (braided cotton)..... |

| NO. | PLATE | NAME |
|--------|-------|---|
| 64805 | 8985 | Arm Rotary Shaft Flanged Bushing Oil Pad, short (braided cotton)..... |
| 159F | 8901 | Arm Rotary Shaft Flanged Bushing Screw..... |
| 49013 | 8904 | " " " " Front Bearing Oil Pad (braided cotton)..... |
| 144D | 8901 | Arm Rotary Shaft Screw..... |
| 15196 | 8902 | " " Side Cover (back)..... |
| 286D | 8904 | " " " " Thumb Screw..... |
| 54010 | 8904 | " " " " (front)..... |
| 286D | 8904 | " " " " Thumb Screw..... |
| 64259 | 9874 | Balance Wheel with two 430c..... |
| 430c | 8904 | " " " " Set Screw..... |
| 54011 | 9880 | Cloth Plate..... |
| 54012 | 8902 | " " Slide (left)..... |
| 38419 | 8904 | " " " " Spring..... |
| 725J | 8904 | " " " " " Screw..... |
| 54013 | --- | Cloth Plate Slide (left) complete, Nos. 38419, 54012 and two 725J..... |
| 68191 | --- | Cloth Plate Slide (right)..... |
| 38419 | 8904 | " " " " Spring..... |
| 725J | 8904 | " " " " " Screw..... |
| 68192 | --- | Cloth Plate Slide (right) complete, Nos. 38419, 68191 and two 725J..... |
| 68267 | --- | Cloth Plate complete, for 1/8 in. to 1/16 in. gauges, for 68163, Nos. 54011, 54013 and 68192..... |
| 1011F | 8904 | Cloth Plate Screw (left)..... |
| 50473F | 8904 | " " " " (right)..... |
| 54104 | 9880 | " " Thread Guard..... |
| 1235c | 9872 | " " " " " Screw..... |
| 54017 | 8902 | Crank Connecting Rod with 6575, 54018, 54218, 54897, 57222 and two each 896E and 1057E..... |
| 54088 | --- | Crank Connecting Rod 54017 with 50069c..... |
| 50069c | 8904 | " " " " Ball Screw Stud..... |
| 1516E | 8904 | " " " " " " " " Nut..... |
| 64268 | 8904 | Crank Connecting Rod Ball Screw Stud Nut Washer..... |
| *57222 | --- | Crank Connecting Rod Cap (lower)..... |
| 896E | 8904 | " " " " " " Screw..... |
| *54018 | --- | " " " " " " (upper)..... |
| 1057E | 8904 | " " " " " " Screw..... |
| 54897 | 8904 | " " " " Oil Cup..... |
| 54218 | 8904 | " " " " " Pad (braided cotton)..... |
| 6575 | 8904 | Crank Connecting Rod Oil Pad Stop Pin..... |

| NO. | PLATE | NAME |
|--------|-------|---|
| 68083 | 9871 | Looper Thread Guide..... |
| 1698E | 9872 | “ “ “ Nut..... |
| 59456 | 9870 | “ “ “ Washer..... |
| 64319 | 9872 | Needle Bar (hollow)..... |
| 54493 | — | Needle Bar complete, Nos. 64319 and 128215..... |
| 38456 | 8961 | Needle Bar Bushing (lower)..... |
| 1133E | 8958 | “ “ “ Set Screw... |
| 64320 | 8961 | “ “ “ (upper)..... |
| 1133E | 8958 | “ “ “ Set Screw... |
| 54326 | 8961 | “ “ Connecting Link..... |
| 54329 | — | “ “ “ 54326 with 54327 and 54328..... |
| 54327 | 8961 | Needle Bar Connecting Link Hinge Stud |
| 1520J | 9872 | “ “ “ “ “ “ Nut..... |
| 54328 | 8961 | Needle Bar Connecting Stud with 211E and two 187E..... |
| 187E | 8958 | Needle Bar Connecting Stud Screw..... |
| 128215 | 9872 | “ Clamp with three 1498E..... |
| 54494 | 9872 | “ Guard, for $\frac{3}{32}$ in. to $\frac{9}{64}$ in. gauges between each needle..... |
| 68247 | — | Needle Guard, for $\frac{3}{32}$ in. to $\frac{3}{16}$ in. gauges between each needle..... |

NOTE: When ordering No. 54494 or 68247, state gauge of machine for which required.

| | | |
|-------|------|--|
| 54038 | 8961 | Needle Guard Holder..... |
| 176D | 8958 | “ “ “ Screw..... |
| 217F | 8904 | “ “ “ Screw..... |
| 1498F | 9872 | “ Set Screw..... |
| 54108 | — | Oil Tube..... |
| 54109 | — | “ “ Bracket..... |
| 49092 | 9870 | “ “ Packing (felt)..... |
| 54110 | 9870 | Oil Tube complete, for oiling Crank Connecting Rod (upper bearing), Nos. 49092, 54108 and 54109..... |
| 64330 | 9873 | Presser Bar with 25303..... |
| 25303 | 8961 | “ “ Ball, size $\frac{1}{4}$ in..... |
| 64331 | 8911 | “ “ Bushing (lower)..... |
| 1133E | 8958 | “ “ “ Set Screw... |
| 38456 | 8961 | “ “ “ (upper)..... |
| 1133E | 8958 | “ “ “ Set Screw... |
| 54039 | 8985 | “ “ Guide Bracket with 453c, 640w and 1963..... |
| 640w | 8958 | Presser Bar Guide Bracket Adjusting Screw..... |

| NO. | PLATE | NAME |
|--------|-------|--|
| 11173 | 8985 | Presser Bar Guide Bracket Guide..... |
| 447c | 8958 | “ “ “ “ “ Set Screw |
| 1963 | 8985 | “ “ “ “ Roller and Stud |
| 453c | 8901 | “ “ “ “ Set Screw..... |
| 57257 | 8911 | “ “ Lifter..... |
| 57258 | 8911 | “ “ “ Hinge Pin..... |
| 447c | 8958 | “ “ “ “ Set Screw... |
| 1872 | 8985 | “ “ “ Roller and Stud..... |
| 1250c | 8911 | “ “ “ Stop Screw..... |
| 61047 | 8911 | “ “ Lifting Bracket with 460c and 1872..... |
| 68208 | 9873 | Presser Bar Lifting Lever..... |
| 61075 | 8911 | “ “ “ “ Connecting Stud |
| 460c | 9872 | “ “ “ “ “ Set Screw..... |
| 68184 | 9873 | Presser Bar Lifting Lever Extension... .. |
| 161D | 8958 | “ “ “ “ “ Screw |
| 802D | 8958 | “ “ “ “ Hinge Screw... .. |
| 54040 | 9873 | “ “ Spring (flat)..... |
| 38468 | 9872 | “ “ “ Stud..... |
| 54495 | — | “ Foot Leveling Plate..... |
| 11184 | 9877 | “ “ “ “ Hinge Pin... .. |
| 68086 | — | “ “ Needle Plate..... |
| 68160 | 9877 | “ “ “ “ Spring (left) .. |
| 68161 | 9877 | “ “ “ “ “ (right) .. |
| 665w | 9877 | “ “ “ “ “ Screw.. |
| 68087 | — | “ “ Plate..... |
| 54498 | — | “ “ Shank..... |
| 51065c | 9877 | “ “ “ Screw..... |
| 68088 | 9877 | Presser Foot (hinged) complete, for $\frac{3}{16}$ in. to $\frac{3}{16}$ in. gauges, Nos. 11184, 54495, 54498, 68086, 68087, 68160, 68161 and two each 665w and 51065c..... |
| 190D | 8958 | Presser Foot Screw..... |
| 574w | 8958 | Pressure Regulating Thumb Screw..... |
| 1539w | 9872 | “ “ “ “ Lock Nut..... |
| 54381 | 9870 | Slack Thread Controller..... |
| 54242 | 9870 | “ “ “ Clamp..... |
| 190D | 8958 | “ “ “ “ Screw... |
| 54500 | 9870 | “ “ Regulator..... |
| 54042 | 9870 | “ “ “ Holder with 175E and two 50150c..... |
| 175E | 8958 | Slack Thread Regulator Holder Clamping Screw..... |

| NO. | PLATE | NAME | | | |
|--------|-------|---------------------------|----------------|-----------------|------------------------|
| 54043 | 9870 | Slack | Thread | Regulator | Holder Shaft |
| 24292 | 9870 | " | " | " | " |
| | | Collar with 1019c..... | | | |
| 1019c | 8958 | Slack | Thread | Regulator | Holder Shaft |
| | | Collar Set Screw..... | | | |
| 54044 | 9870 | Slack | Thread | Regulator | Holder Crank |
| | | (forked) with 1253c..... | | | |
| 1253c | --- | Slack | Thread | Regulator | Holder Crank |
| | | Set Screw..... | | | |
| 50150c | 8958 | Slack | Thread | Regulator | Set Screw..... |
| 2102 | 8964 | Tension | (under thread) | Disc..... | |
| 68001 | 9871 | " | " | " | Plate..... |
| 742F | 9872 | " | " | " | Screw..... |
| 51570c | 8964 | " | " | " | Regulating Thumb |
| | | Nut..... | | | |
| 50326c | 8964 | Tension | (under thread) | Screw Stud..... | |
| 59539 | --- | " | " | " | 50326c |
| | | with 51570c..... | | | |
| 59534 | 8964 | Tension | (under thread) | Spring..... | |
| 59537 | 8964 | " | " | " | Bushing |
| | | (large)..... | | | |
| 59538 | 8964 | Tension | (under thread) | Spring | Bushing |
| | | (small)..... | | | |
| 57076 | 8964 | Tension | (upper thread) | Thread Guide | |
| | | (double)..... | | | |
| 68004 | 9871 | Thread | (under) | Eyelet | (back)..... |
| 190d | 8958 | " | " | " | Screw..... |
| 68005 | 9871 | " | " | " | (front)..... |
| 64351 | 9870 | " | " | Nipper | Cam with 465c.. |
| 465c | 8958 | " | " | " | Set Screw... |
| 38210 | 9870 | " | " | " | Spring (lower).. |
| 38211 | 9870 | " | " | " | (upper) |
| 46247 | 9870 | " | " | " | " |
| | | Stop..... | | | |
| 176d | 8958 | Thread | (under) | Nipper | Spring Screw... |
| 38475 | 9876 | " | " | " | Take-up with 465c..... |
| 465c | 8958 | " | " | " | Set Screw..... |
| 68165 | 9871 | " | " | " | Staple..... |
| 54049 | 9873 | " | " | " | Bracket |
| | | with 460c..... | | | |
| 965d | 9872 | Thread | (under) | Take-up | Staple Bracket |
| | | Screw..... | | | |
| 46041 | 9871 | Thread | (under) | Take-up | Staple Spring |
| 190d | 8958 | " | " | " | " |
| | | Screw..... | | | |
| 38482 | 9871 | Thread | (under) | Take-up | Stripper..... |
| 207d | 9872 | " | " | " | Screw... |
| 64355 | 9871 | " | " | " | Thread Guard |
| | | (brass)..... | | | |
| 64356 | 9871 | Thread | (under) | Take-up | Thread Guard |
| | | Steady Pin..... | | | |
| 460c | 9872 | Thread | (under) | Take-up | Thread Guard |
| | | Steady Pin Set Screw..... | | | |
| 54330 | 9871 | Thread | (upper) | Controller..... | |
| 207d | 9872 | " | " | " | Screw..... |
| 68006 | 9871 | " | " | Eyelet..... | |
| 176d | 8958 | " | " | " | Screw..... |
| 68007 | 9871 | " | " | Take-up..... | |
| 68008 | 9871 | " | " | " | Plate..... |
| 68164 | 9871 | " | " | " | Spring |
| 1449d | 9872 | " | " | " | " |
| | | Screw..... | | | |

| NO. | PLATE | NAME | | | |
|--------|-------|---------------------------|----------------|-----------------|------------------------|
| 50326c | 8964 | Tension | (upper thread) | Screw Stud..... | |
| 59539 | --- | " | " | " | 50326c |
| | | with 51570c..... | | | |
| 59535 | 8964 | Tension | (upper thread) | Spring..... | |
| 59537 | 8964 | " | " | " | Bushing |
| | | (large)..... | | | |
| 59538 | 8964 | Tension | (upper thread) | Spring | Bushing |
| | | (small)..... | | | |
| 57076 | 8964 | Tension | (upper thread) | Thread Guide | |
| | | (double)..... | | | |
| 68004 | 9871 | Thread | (under) | Eyelet | (back)..... |
| 190d | 8958 | " | " | " | Screw..... |
| 68005 | 9871 | " | " | " | (front)..... |
| 64351 | 9870 | " | " | Nipper | Cam with 465c.. |
| 465c | 8958 | " | " | " | Set Screw... |
| 38210 | 9870 | " | " | " | Spring (lower).. |
| 38211 | 9870 | " | " | " | (upper) |
| 46247 | 9870 | " | " | " | " |
| | | Stop..... | | | |
| 176d | 8958 | Thread | (under) | Nipper | Spring Screw... |
| 38475 | 9876 | " | " | " | Take-up with 465c..... |
| 465c | 8958 | " | " | " | Set Screw..... |
| 68165 | 9871 | " | " | " | Staple..... |
| 54049 | 9873 | " | " | " | Bracket |
| | | with 460c..... | | | |
| 965d | 9872 | Thread | (under) | Take-up | Staple Bracket |
| | | Screw..... | | | |
| 46041 | 9871 | Thread | (under) | Take-up | Staple Spring |
| 190d | 8958 | " | " | " | " |
| | | Screw..... | | | |
| 38482 | 9871 | Thread | (under) | Take-up | Stripper..... |
| 207d | 9872 | " | " | " | Screw... |
| 64355 | 9871 | " | " | " | Thread Guard |
| | | (brass)..... | | | |
| 64356 | 9871 | Thread | (under) | Take-up | Thread Guard |
| | | Steady Pin..... | | | |
| 460c | 9872 | Thread | (under) | Take-up | Thread Guard |
| | | Steady Pin Set Screw..... | | | |
| 54330 | 9871 | Thread | (upper) | Controller..... | |
| 207d | 9872 | " | " | " | Screw..... |
| 68006 | 9871 | " | " | Eyelet..... | |
| 176d | 8958 | " | " | " | Screw..... |
| 68007 | 9871 | " | " | Take-up..... | |
| 68008 | 9871 | " | " | " | Plate..... |
| 68164 | 9871 | " | " | " | Spring |
| 1449d | 9872 | " | " | " | " |
| | | Screw..... | | | |

| NO. | PLATE | NAME |
|--|-------|--|
| 68009 | ---- | Thread (upper) Take-up complete, Nos. 1449b, 68007, 68008 and 68164..... |
| 211F | 8958 | Thread (upper) Take-up Set Screw..... |
| 86163 | 9876 | Throat Plate, for $\frac{1}{8}$ in. to $\frac{3}{16}$ in. gauges, for 68162..... |
| NOTE: When ordering 68163, state gauge required. | | |
| 742F | 9872 | Throat Plate Screw..... |

ACCESSORIES

| NO. | PLATE | NAME |
|--------|-------|--|
| 120344 | 8941 | Oiler (copper plated) with 120345..... |
| 120345 | 8941 | " Spout, 5 in. long..... |
| 26026 | 8941 | Screw Driver (large)..... |
| 26485 | 8941 | " " (small)..... |
| 38487 | 8941 | Threading Wire..... |
| 120341 | 8941 | Tweezers (curved)..... |
| 8908 | 8941 | Wrench for 1520..... |
| 19221 | 8941 | " " 1516..... |
| 4822 | 8941 | " " 1547..... |

BELT GUARD

| NO. | PLATE | NAME |
|-------|-------|---|
| 68222 | 9879 | Belt Guard with two wood screws 1 in. No. 12..... |

BENCH STAND

| NO. | PLATE | NAME |
|--------|-------|--|
| 79611 | --- | Bench Stand with 5604, 9370, two 41538, three wood screws $1\frac{1}{4}$ in. No. 14, four 60656 and sixteen wood screws $\frac{5}{8}$ in. No. 7..... |
| 41538 | --- | Flush Bolt with Plate complete, Nos. 126247, 126248 and four brass wood screws $\frac{5}{8}$ in. No. 4..... |
| 126247 | 8952 | Flush Bolt..... |
| 126248 | 8952 | " " Plate..... |
| 60656 | 8952 | Hinge..... |
| 9370 | 8952 | Slide Spring..... |
| 5604 | 8952 | " " Pin..... |

FITTINGS FOR OVERALL WORK

FOR 147-30 MACHINE

| NO. | PLATE | NAME |
|--------|-------|---|
| 54489 | 9875 | Feed Dog, 22 teeth (14 teeth to the inch) for 68010..... |
| 68072 | 9875 | Feed Dog, 14 teeth (19 teeth to the inch) for 68073..... |
| 120524 | 9878 | Lap Seam Feller on Shank..... |
| 54495 | ---- | Presser Foot Leveling Plate..... |
| 11184 | 9877 | " " " " Hinge Pin..... |
| 54496 | ---- | " " Needle Plate for 54499..... |
| 68086 | ---- | " " " " 68088..... |
| 68160 | 9877 | " " " " Spring (left)..... |
| 68161 | 9877 | " " " " " (right)..... |
| 665w | 9877 | " " " " " Screw..... |
| 54497 | ---- | " " Plate for 54499..... |
| 68087 | ---- | " " " " 68088..... |
| 54498 | ---- | " " Shank..... |
| 51065c | 9877 | " " " Hinge Screw..... |
| 54499 | 9877 | Presser Foot (hinged) complete, for $\frac{3}{32}$ in. to $\frac{1}{8}$ in. gauges, Nos. 11184, 54495 to 54498, 68160, 68161 and two each 665w and 51065c..... |
| 68088 | 9877 | Presser Foot (hinged) complete, for $\frac{1}{16}$ in. to $\frac{3}{16}$ in. gauges, Nos. 11184, 54495, 54498, 68086, 68087, 68160, 68161 and two each 665w and 51065c..... |
| 68010 | 9875 | Throat Plate, for $\frac{1}{2}$ in. to $\frac{9}{16}$ in. gauges, for 54489..... |
| 68073 | 9875 | Throat Plate, for $\frac{5}{32}$ in. to $\frac{3}{16}$ in. gauges, for 68072..... |

FITTINGS FOR HEAVY OVERALL WORK

FOR 147-31 MACHINE

| NO. | PLATE | NAME |
|--------|-------|--|
| 68162 | 9876 | Feed Dog, 15 teeth (10 teeth to the inch) for 68163..... |
| 120524 | 9878 | Lap Seam Feller on Shank..... |
| 120707 | 9878 | " " " " " to allow for taking work out of folder and finishing pocket seams..... |

| NO. | PLATE | NAME |
|--------|-------|--|
| 54495 | — | Presser Foot Leveling Plate..... |
| 11184 | 9877 | " " " " Hinge Pin... |
| 54496 | — | " " Needle Plate for 54499..... |
| 68086 | — | " " " " " 68088..... |
| 68160 | 9877 | " " " " Spring (left)... |
| 68161 | 9877 | " " " " " (right)... |
| 665w | 9877 | " " " " " Screw... |
| 54497 | — | " " Plate for 54499..... |
| 68087 | — | " " " " 68088..... |
| 54498 | — | " " Shank..... |
| 51065c | 9877 | " " " Hinge Screw..... |
| 54499 | 9877 | Presser Foot (hinged) complete, for $\frac{3}{8}$ in. to $\frac{1}{8}$ in. gauges, Nos. 11184, 54495 to 54498, 68160, 68161 and two each 665w and 51065c..... |
| 68088 | 9877 | Presser Foot (hinged) complete, for $\frac{9}{16}$ in. to $\frac{3}{8}$ in. gauges, Nos. 11184, 54495, 54498, 68086, 68087, 68160, 68161 and two each 665w and 51065c..... |
| 68163 | 9876 | Throat Plate, for $\frac{1}{8}$ in. to $\frac{3}{16}$ in. gauges... |

FITTINGS FOR SHIRT WORK

FOR 147-30 MACHINE

| NO. | PLATE | NAME |
|--------|-------|--|
| 54489 | 9875 | Feed Dog, 22 teeth (14 teeth to the inch) for 68010..... |
| 120524 | 9878 | Lap Seam Feller on Shank..... |
| 26276 | 9877 | Presser Foot Hinge Pin..... |
| 68026 | — | " " Plate for 68027..... |
| 68202 | — | " " " " 68203..... |
| 46087 | — | " " Shank..... |
| 68027 | 9877 | Presser Foot (hinged) with guide on bottom, complete, for $\frac{3}{8}$ in. to $\frac{9}{16}$ in. gauges, Nos. 26276, 46087 and 68026..... |
| 68203 | 9877 | Presser Foot (hinged) plain bottom, complete, for $\frac{3}{8}$ in. to $\frac{9}{16}$ in. gauges, Nos. 26276, 46087 and 68202..... |
| 26276 | 9877 | Presser Foot Hinge Pin..... |
| 120753 | — | " " Plate with Edge Folder.... |
| 46087 | — | " " Shank..... |
| 120754 | 9877 | Presser Foot (hinged) with Edge Folder complete, for yoking, for $\frac{3}{8}$ in. to $\frac{9}{16}$ in. gauges, Nos. 26276, 46087 and 120753..... |
| 68010 | 9875 | Throat Plate, for $\frac{3}{8}$ in. to $\frac{9}{16}$ in. gauges, for 54489..... |

FOOT LIFTER PARTS

| NO. | PLATE | NAME |
|------|-------|--|
| 6439 | — | Chain, 36 in. to 45 in., with 56864 and 56865..... |

NOTE: When ordering No. 6439, state length required.

| | | |
|--------|------|---|
| 4879 | 8941 | Chain Connecting Link..... |
| 56864 | 8941 | " Hook (large)..... |
| 56865 | 8985 | " " (small)..... |
| 126249 | 8980 | Treadle..... |
| 4882 | 8941 | " Shaft..... |
| 126250 | 8941 | " Spring..... |
| 126251 | 8980 | " Stand..... |
| 126252 | 8980 | Treadle complete, Nos. 4882, 126249 to 126251 and two wood screws 1 in. No. 6439..... |

KNEE LIFTER PARTS

| NO. | PLATE | NAME |
|-------|-------|---|
| 37563 | — | Chain, length 15 in., with 56864 and 56865..... |
| 56864 | 8941 | " Hook (large)..... |
| 56865 | 8985 | " " (small)..... |
| 2763 | 8980 | Rock Shaft..... |
| 12242 | 8980 | " " Hanger with two wood screws 1 in. No. 10..... |
| 6335 | 8980 | Rock Shaft Knee Arm..... |
| 6336 | — | Rock Shaft Knee Arm complete, Nos. 2766, 2767 and 6335..... |
| 2766 | 8980 | Rock Shaft Knee Arm Hub with 356c..... |
| 356c | 8985 | " " " " " Set Screw..... |
| 2767 | 8980 | " " " Plate with 356c..... |
| 356c | 8985 | " " " " Set Screw..... |
| 6337 | 8980 | " " Lifting Bracket with two 356c..... |
| 7125 | 8980 | " " " " Hook..... |
| 356c | 8985 | " " " " " Set Screw..... |
| 356c | 8985 | Rock Shaft Lifting Bracket Set Screw..... |
| 2770 | 8980 | " " Stop Dog with 356c..... |
| 356c | 8985 | " " " " Set Screw..... |
| 23767 | 8980 | Rock Shaft complete, Nos. 2763, 2770, 6336, 6337, 7125 and two 12242..... |

From the library of Diamond Needle Corp.

LAP SEAM FELLERS

| NO. | PLATE | NAME |
|--------|-------|--|
| 120524 | 9878 | Lap Seam Feller on Shank..... |
| 120707 | 9878 | “ “ “ “ “ for heavy over- all work, to allow for taking work out of folder and finishing pocket seams... |

MACHINE BASE

| NO. | PLATE | NAME |
|--------|-------|--|
| 68223 | 9879 | Machine Base..... |
| 51072E | 9872 | “ “ Bolt with 51581E..... |
| 51581E | 9872 | “ “ “ Nut..... |
| 6055 | 9872 | “ “ “ “ Washer..... |
| 49123 | 8996 | “ “ Oil Pipe..... |
| 60884 | 8985 | “ “ “ “ Plug..... |
| 57285 | 8996 | “ Cushion (felt)..... |
| 948E | 8958 | “ Screw, to fasten machine to base |
| 68224 | ----- | Machine Base complete, Nos. 49123, 60884, 68223, three each 6055, 51072E and four each 948E and 57285..... |

THREAD UNWINDER

FOR SIX SPOOLS

| NO. | PLATE | NAME |
|---------|-------|--|
| 225395 | 8997 | Spool Rest, for two spools, with 201018c. |
| 225388 | 8997 | “ “ Rod..... |
| 200383c | 8985 | “ “ “ Set Screw..... |
| 201018c | 8985 | “ “ Set Screw..... |
| 202490 | 8997 | “ Stand with 200383c..... |
| 225391 | 8997 | Thread Guide..... |
| 201696j | 9872 | “ “ Lock Nut..... |
| 225392 | 8997 | “ “ Rod with 208E and 225393 |
| 208E | 8985 | “ “ “ Screw..... |
| 225393 | 9872 | “ “ “ Washer..... |
| 225378 | 8997 | Thread Unwinder complete, Nos. 201696j, 202490, 225388, 225392, three each 225395, six 225391 and three wood screws $\frac{7}{8}$ in. No. 12..... |
| 27739 | 8996 | Thread Cone (wood) for large cones.... |
| 225390 | 8996 | “ “ Holder, for inverted cones.. |

NOTE: Nos. 27739 and 225390 are used with,
but not included in 225378.

OBSOLETE PARTS

| NO. | PLATE | NAME |
|-------|-------|---|
| 54356 | 8980 | Belt Guard with 1192c..... |
| 27347 | 8985 | “ “ Hinge Pin..... |
| 1192c | 8985 | “ “ “ “ Set Screw..... |
| 1192c | 8985 | “ “ “ “ Set Screw..... |
| 64362 | 8996 | Presser Bar Lifting Lever..... |
| 54103 | 9873 | “ “ “ “ Extension.... |
| 54357 | 8980 | Machine Base with 1192c..... |
| 54358 | ----- | Machine Base with Belt Guard complete, Nos. 27347, 49123, 54356, 54357, 60884, three each 6055, 51072E and four each 948E and 57285..... |
| 54990 | 8964 | Tension (upper thread) Releasing Shaft Spring..... |

Genuine Singer Needles and their Con-
tainers are marked with the Company's
Trade Mark "SIMANCO." 1

Needles in Containers marked
"For Singer Machines"
are not Singer made needles. 2

From the library of: Diamond Needle Co.

NUMERICAL LIST OF PARTS

FOR

MACHINES

Nos. 147-30 and 147-31

NUMERICAL LIST OF PARTS

| NO. PLATE | NAME |
|-----------|---|
| 144D 8901 | Arm Rotary Shaft Screw..... |
| 157W 8904 | Feed Dog Screw..... |
| 159F 8901 | Arm Rotary Shaft Flanged Bushing Screw |
| 161D 8958 | Presser Bar Lifting Lever Extension Screw |
| 171D 8958 | Looper Carrier Adjusting Screw for 54027 |
| 175E 8958 | “ “ Driver Cap Screw for 54230 |
| 175E 8958 | Slack Thread Regulator Holder Clamping Screw for 54042..... |
| 176D 8958 | Needle Guard Holder Screw..... |
| 176D 8958 | Thread (under) Nipper Spring Screw... |
| 176D 8958 | “ (upper) Eyelet Screw..... |
| 187E 8958 | Needle Bar Connecting Stud Screw for 54328..... |
| 190D 8958 | Presser Foot Screw..... |
| 190D 8958 | Thread (under) Eyelet (back) Screw... |
| 190D 8958 | “ “ Take-up Staple Spring Screw..... |
| 190D 8958 | Slack Thread Controller Clamp Screw... |
| 207D 9872 | Thread (under) Take-up Stripper Screw... |
| 207D 9872 | Thread (upper) Controller Screw..... |
| 208E 8985 | “ Unwinder Thread Guide Rod Screw for 225392..... |
| 211F 8958 | Thread (upper) Take-up Set Screw for 54328..... |
| 217D 8904 | Feed Eccentric Clamping Washer Screw for 54025..... |
| 217D 8904 | Needle Guard Screw..... |
| 227D 8958 | Looper Driving Shaft and Feed Lifting Eccentric Bracket Oil Hole Screw for 54368..... |
| 229D 8958 | Looper (front) Screw (left) for 68015 |
| 236D 9872 | Face Plate Thread Guard Screw..... |
| 286D 8904 | Arm Side Cover (back) Thumb Screw.... |
| 286D 8904 | “ “ “ (front) Thumb Screw.... |
| 286D 8904 | Face Plate Thumb Screw..... |
| 316F 8958 | Tension (upper thread) Releasing Shaft Stop Screw..... |
| 356c 8985 | Rock Shaft Knee Arm Hub Set Screw for 2766..... |
| 356c 8985 | Rock Shaft Knee Plate Set Screw for 2767 |
| 356c 8985 | “ “ Lifting Bracket Hook Set Screw for 6337..... |

| NO. PLATE | NAME |
|-----------|---|
| 356c 8985 | Rock Shaft Lifting Bracket Set Screw for 6337..... |
| 356c 8985 | Rock Shaft Stop Dog Set Screw for 2770 |
| 376d 8958 | Tension (upper thread) Bracket Screw... |
| 422c 8901 | Arm Rotary Shaft Bushing (intermediate) Set Screw (long)..... |
| 423c 8901 | Arm Rock Shaft Bushing (intermediate) Set Screw..... |
| 430c 8904 | Balance Wheel Set Screw for 64259..... |
| 446c 8901 | Arm Rock Shaft Bushing (back) Set Screw |
| 446c 8901 | Looper Carrier Connection Shaft Bushing Set Screw..... |
| 447c 8958 | Presser Bar Guide Bracket Guide Set Screw..... |
| 447c 8958 | Presser Bar Lifter Hinge Pin Set Screw... |
| 453c 8901 | Arm Rock Shaft Collar Set Screw for 51001..... |
| 453c 8901 | Arm Rock Shaft Crank (front) Set Screw for 64255..... |
| 453c 8901 | Arm Rock Shaft Flanged Bushing Front Set Screw..... |
| 453c 8901 | Feed Bar Hinge Pin Set Screw for 54488. |
| 453c 8901 | “ Rocking Frame Hinge Pin Bushing Set Screw..... |
| 453c 8901 | Feed Rocking Frame Hinge Pin Set Screw for 54026..... |
| 453c 8901 | Presser Bar Guide Bracket Set Screw for 54039..... |
| 457c 8904 | Feed Connecting Rod Hinge Pin Collar Set Screw for 21506..... |
| 460c 9872 | Presser Bar Lifting Lever Connecting Stud Set Screw for 61047..... |
| 460c 9872 | Thread (under) Take-up Thread Guard Steady Pin Set Screw for 54049..... |
| 465c 8958 | Thread (under) Nipper Cam Set Screw for 64351..... |
| 465c 8958 | Thread (under) Take-up Set Screw for 38475..... |
| 574w 8958 | Pressure Regulating Thumb Screw..... |
| 924c 8958 | Tension (upper thread) Releasing Shaft Crank Set Screw for 54047..... |
| 640d 8958 | Looper Driving Shaft and Feed Lifting Eccentric Screw for 54384 and 68111.. |
| 640w 8958 | Presser Bar Guide Bracket Adjusting Screw for 54039..... |
| 665w 9877 | Presser Foot Needle Plate Spring Screw for 54499 and 68088..... |

| NO. PLATE | NAME |
|------------|--|
| 704w 8958 | Looper Holder Screw..... |
| 725i 8904 | Cloth Plate Slide (left) Spring Screw for 54013..... |
| 725j 8904 | Cloth Plate Slide (right) Spring Screw for 54056, 54058 and 68192..... |
| 742f 9872 | Tension (under thread) Plate Screw..... |
| 742f 9872 | Throat Plate Screw..... |
| 761e 8901 | Looper Driving Shaft and Feed Lifting Eccentric Bracket Bushing Set Screw for 54034..... |
| 802d 8958 | Presser Bar Lifting Lever Hinge Screw... |
| 896e 8904 | Crank (Connecting Rod Cap (lower) Screw for 54017..... |
| 896e 8904 | Feed Connecting Rod Cap Screw for 54111 |
| 948d 8958 | Looper Driving Shaft and Feed Lifting Eccentric Bracket Screw for 54001 and 68109..... |
| 948e 8958 | Machine Screw, to fasten machine to base, for 54358 and 68224..... |
| 965d 9872 | Thread (under) Take-up Staple Bracket Screw..... |
| 1011f 8904 | Cloth Plate Screw (left)..... |
| 1019c 8958 | Slack Thread Regulator Holder Shaft Collar Set Screw for 24292..... |
| 1057e 8904 | Crank Connecting Rod Cap (upper) Screw for 54017..... |
| 1057e 8904 | Feed Connecting Rod Clamping Screw for 54111..... |
| 1103c 8904 | Feed Regulating Screw for 54025..... |
| 1120c 8958 | Looper (intermediate) Set Screw for 54061 |
| 1133e 8958 | Needle Bar Bushing (lower) Set Screw... |
| 1133c 8958 | “ “ “ (upper) Set Screw... |
| 1133c 8958 | Presser Bar Bushing (lower) Set Screw... |
| 1133c 8958 | “ “ “ (upper) Set Screw... |
| 1147c 9872 | Looper (back) Set Screw for 54061..... |
| 1192c 8985 | Belt Guard Hinge Pin Set Screw for 54357, obsolete..... |
| 1192c 8985 | Belt Guard Set Screw for 54356, obsolete |
| 1235d 9872 | Cloth Plate Thread Guard Screw..... |
| 1250c 8911 | Presser Bar Lifter Stop Screw..... |
| 1253c — | Slack Thread Regulator Holder Shaft Crank Set Screw for 54044..... |
| 1259c 8958 | Arm Rotary Shaft Collar Set Screw for 54008..... |
| 1302d 9872 | Looper (front) Screw (right) for 68015... |
| 1449d 9872 | Thread (upper) Take-up Plate Spring Screw for 68009..... |

| NO. | PLATE | NAME |
|-------|-------|---|
| 1498F | 9872 | Needle Set Screw for 128215..... |
| 1516E | 8904 | Crank Connecting Rod Ball Screw Stud Nut..... |
| 1520J | 9872 | Needle Bar Connecting Link Hinge Stud Nut..... |
| 1539W | 9872 | Pressure Regulating Thumb Screw Lock Nut..... |
| 1547J | 9872 | Tension (upper thread) Releasing Shaft Stop Screw Nut..... |
| 1698E | 9872 | Looper Thread Guide Nut..... |
| 1872 | 8985 | Presser Bar Lifter Roller and Stud for 61047..... |
| 1963 | 8985 | Presser Bar Guide Bracket Roller and Stud for 54039..... |
| 2102 | 8964 | Tension (under thread) Disc..... |
| 2102 | 8964 | " (upper thread) Disc..... |
| 2117 | 8901 | Arm Rock Shaft Crank (front) Pin..... |
| 2763 | 8980 | Rock Shaft for 23767..... |
| 2766 | 8980 | Rock Shaft Knee Arm Hub with 356c, for 6336..... |
| 2767 | 8980 | Rock Shaft Knee Plate with 356c, for 6336 |
| 2770 | 8980 | " " Stop Dog with 356c, for 23767 |
| 4822 | 8941 | Wrench for 1547 (Accessories)..... |
| 4879 | 8941 | Chain Connecting Link..... |
| 4882 | 8941 | Treadle Shaft for 126252..... |
| 5604 | 8952 | Bench Stand Slide Spring Pin for 79611.. |
| 6055 | 9872 | Machine Base Bolt Nut Washer for 54358 and 68224..... |
| 6335 | 8980 | Rock Shaft Knee Arm for 6336..... |
| 6336 | — | Rock Shaft Knee Arm complete for 23767, Nos. 2766, 2767 and 6335..... |
| 6337 | 8980 | Rock Shaft Lifting Bracket with two 356c for 23767..... |
| 6439 | — | Chain, 36 in. to 45 in., with 56864 and 56865..... |
| 6575 | 8904 | Crank Connecting Rod Oil Pad Stop Pin for 54017..... |
| 7071 | 8904 | Feed Eccentric Clamping Washer for 54025..... |
| 7125 | 8980 | Rock Shaft Lifting Bracket Hook for 23767..... |
| 8909 | 8941 | Wrench for 1520 (Accessories)..... |
| 9370 | 8952 | Bench Stand Slide Spring for 79611..... |
| 11173 | 8985 | Presser Bar Guide Bracket Guide..... |
| 11184 | 9877 | Presser Foot Leveling Plate Hinge Pin for 54499 and 68088..... |

| NO. | PLATE | NAME |
|--------|-------|--|
| 12242 | 8980 | Rock Shaft Hanger with two wood screws, 1 in. No. 10 for 23767..... |
| 15196 | 8902 | Arm Side Cover (back)..... |
| 17547 | 8964 | Tension (under thread) Thread Guide.... |
| 19221 | 8941 | Wrench for 1516 (Accessories)..... |
| 21506 | 8904 | Feed Connecting Rod Hinge Pin Collar with 457c, for 68022..... |
| *23729 | — | Feed Eccentric Body for 54025..... |
| 23767 | 8980 | Rock Shaft complete, Nos. 2763, 2770, 6336, 6337, 7125 and two 12242..... |
| 24292 | 9870 | Slack Thread Regulator Holder Shaft Collar with 1019c..... |
| 25303 | 8961 | Presser Bar Ball, size ¼ in., for 64330... |
| 26026 | 8941 | Screw Driver, large (Accessories)..... |
| 26276 | 8911 | Presser Foot Hinge Pin for 68027, 68203 and 120754..... |
| 26485 | 8941 | Screw Driver, small (Accessories)..... |
| 27347 | 8985 | Belt Guard Hinge Pin for 54358, obsolete |
| 27739 | 8996 | Thread Cone (wood) for large cones.... |
| 32572 | 8964 | Tension (upper thread) Releasing Disc... |
| 37563 | — | Chain, length 15 in., with 56864 and 56865 |
| 38210 | 9870 | Thread (under) Nipper Spring (lower)... |
| 38211 | 9870 | " " " " (upper)... |
| 38419 | 8904 | Cloth Plate Slide (left) Spring for 54013. |
| 38419 | 8904 | " " " (right) Spring for 54056, 54058 and 68192..... |
| 38456 | 8961 | Needle Bar Bushing (lower)..... |
| 38456 | 8961 | Presser Bar Bushing (upper)..... |
| 38468 | 9872 | Presser Bar Spring Stud..... |
| 38475 | 9876 | Thread (under) Take-up with 465c..... |
| 38482 | 9871 | " " " Stripper..... |
| 38487 | 8941 | Threading Wire (Accessories)..... |
| 40326 | 8961 | Looper Driving Shaft and Feed Lifting Eccentric Oil Pad (braided cotton).... |
| 41538 | — | Bench Stand Flush Bolt with Plate complete for 79611, Nos. 126247, 126248 and four brass wood screws ⅝ in. No. 4 |
| 42366 | 8901 | Arm Oil Pad (braided cotton) for oiling Arm Rock Shaft Front Bearing..... |
| 46041 | 9871 | Thread (under) Take-up Staple Spring... |
| 46087 | — | Presser Foot Shank for 68027, 68203 and 120754..... |
| 46111 | 8911 | Face Plate Pin..... |
| 46247 | 9870 | Thread (under) Nipper Spring (upper) Stop..... |
| 49013 | 8904 | Arm Rotary Shaft Front Bearing Oil Pad (braided cotton)..... |

| NO. | PLATE | NAME |
|--------|-------|---|
| 54048 | 8964 | Tension (upper thread) Releasing Shaft Crank Link..... |
| 54049 | 9873 | Thread (under) Take-up Staple Bracket with 460c..... |
| 54055 | 9874 | Cloth Plate Slide (right) for 54056..... |
| 54056 | --- | Cloth Plate Slide (right) complete for 54059, Nos. 38419, 54055 and two 725j |
| 54057 | 9874 | Cloth Plate Slide (right) for 54058..... |
| 54058 | --- | Cloth Plate Slide (right) complete for 54060, Nos. 38419, 54057 and two 725j |
| 54059 | --- | Cloth Plate complete, for $\frac{3}{32}$ in. and $\frac{7}{64}$ in. gauges, for 68010, for 147-30 Machine, Nos. 54011, 54013 and 54056..... |
| 54060 | --- | Cloth Plate complete, for $\frac{1}{8}$ in. and $\frac{9}{64}$ in. gauges, for 68010, for 147-30 Machine, Nos. 54011, 54013 and 54058..... |
| 54061 | 9869 | Looper Holder with 1120c and 1147c.... |
| 54079 | --- | Arm Rock Shaft 54002 with 54004, 54005 and 64255..... |
| 54080 | 9876 | Looper Driving Shaft and Feed Lifting Eccentric Bracket Bushing..... |
| 54088 | --- | Crank Connecting Rod 54017 with 50069, for 54384 and 68111..... |
| 54089 | --- | Arm Rotary Shaft Bushing (intermediate) 54007 with 64508 and 64805..... |
| 54090 | --- | Arm Rotary Shaft Flanged Bushing 54009 with 58039 and 64805..... |
| 54103 | 9873 | Presser Bar Lifting Lever Extension, obsolete..... |
| 54104 | 9880 | Cloth Plate Thread Guard..... |
| 54105 | 8901 | Arm Rock Shaft Flanged Bushing (front) |
| 54108 | --- | Oil Tube for 54110..... |
| 54109 | --- | " " Bracket for 54110..... |
| 54110 | 9870 | Oil Tube complete, for oiling Crank Connecting Rod (upper bearing), Nos. 49092, 54108 and 54109..... |
| 54111 | 8902 | Feed Connecting Rod with 1057E, 54112 and two 896E, for 54113..... |
| *54112 | --- | Feed Connecting Rod Cap for 54111.... |
| 54113 | --- | " " " 54111 with 54025, for 54384 and 68111..... |
| 54218 | 8904 | Crank Connecting Rod Oil Pad (braided cotton) for 54017..... |
| 54227 | 9869 | Looper Carrier Connection for 54383.... |
| 54228 | 9869 | " " " Shaft for 54382 |
| 54229 | 9876 | " " " " Bushing |

| NO. | PLATE | NAME |
|--|-------|--|
| 54230 | 9869 | Looper Carrier Driver with 54032 and four 175E, for 54383..... |
| 54242 | 9870 | Slack Thread Controller Clamp..... |
| 54326 | 8961 | Needle Bar Connecting Link for 54329... |
| 54327 | 8961 | " " " " Hinge Stud for 54329..... |
| 54328 | 8961 | Needle Bar Connecting Stud with 211F and two 187E, for 54329..... |
| 54329 | --- | Needle Bar Connecting Link 54326 with 54327 and 54328..... |
| 54330 | 9871 | Thread (upper) Controller..... |
| 54356 | 8980 | Belt Guard with 1192c, for 54358, obsolete |
| 54357 | 8980 | Machine Base with 1192c, for 54358, obsolete..... |
| 54358 | --- | Machine Base with Belt Guard complete, Nos. 27347, 49123, 54356, 54357, 60884, three each 6055, 51072E and four each 948E and 57285, obsolete..... |
| 54367 | 8985 | Arm Rotary Shaft Bushing (front)..... |
| *54368 | 8961 | Looper Driving Shaft and Feed Lifting Eccentric with 227D and two 64315, for 54383..... |
| NOTE: When No. 54368 is required for repairs, the Arm Rotary Shaft must be returned to the factory to be adjusted to the new part. | | |
| 54381 | 9870 | Slack Thread Controller..... |
| 54383 | --- | Looper Driving Shaft and Feed Lifting Eccentric 54368 with 54027, 54227, 54228 and 54230, for 54384 and 68111 |
| 54384 | --- | Arm Rotary Shaft 54006 with 640D, 54008, 54088, 54113, 54383, 64351 and 64355, for 147-30 Machine..... |
| 54486 | 9874 | Face Plate..... |
| 54487 | 9871 | " " Thread Guard..... |
| 54488 | 9874 | Feed Bar with 50429c and two 453c, for 68022..... |
| 54489 | 9875 | Feed Dog, 22 teeth (14 teeth to the inch) for 68010..... |
| 54490 | 9869 | Looper (back) closed eye..... |
| 54491 | 9869 | " (front) closed eye, for 68015..... |
| 54492 | 9869 | " (intermediate) closed eye, for 68015 |
| 54493 | --- | Needle Bar complete, Nos. 64319 and 128215..... |
| 54494 | 9872 | Needle Guard, for $\frac{3}{32}$ in. to $\frac{9}{64}$ in. gauges between each needle..... |

| NO. | PLATE | NAME |
|--------|-------|---|
| 54495 | --- | Presser Foot Leveling Plate for 54499 and 68088..... |
| 54496 | --- | Presser Foot Needle Plate for 54499..... |
| 54497 | --- | " " Plate for 54499..... |
| 54498 | --- | Presser Foot Shank for 54499 and 68088. |
| 54499 | 9877 | " " (hinged) complete, for $\frac{3}{32}$ in. to $\frac{1}{8}$ in. gauges, for overall work, Nos. 11184, 54495 to 54498, 68160, 68161 and two each 665w and 51065c..... |
| 54500 | 9870 | Slack Thread Regulator..... |
| 54897 | 8904 | Crank Connecting Rod Oil Cup for 54017 |
| 54988 | 8964 | Tension (upper thread) Releasing Pin.. |
| 54990 | 8964 | " " " " Shaft Spring, obsolete..... |
| 56003 | 8985 | Arm Oil Tube with 52045, for oiling 54326 |
| 56006 | 8901 | " " Pad (braided cotton) for oiling Arm Rock Shaft (intermediate) Bearing |
| 56864 | 8941 | Chain Hook (large) for 6439..... |
| 56865 | 8985 | " " (small) for 6439..... |
| 57076 | 8964 | Tension (upper thread) Thread Guide (double)..... |
| *57222 | --- | Crank Connecting Rod Cap (lower) for 54017..... |
| 57225 | 8904 | Feed Bar Hinge Pin for 68022..... |
| 57234 | 8911 | " Rocking Frame Hinge Pin..... |
| 57235 | 8985 | " " " " " Bushing. |
| 57257 | 8911 | Presser Bar Lifter..... |
| 57258 | 8911 | " " " Hinge Pin..... |
| 57285 | 8996 | Machine Cushion (felt) for 54358 and 68224..... |
| 58039 | 8902 | Arm Rotary Shaft Flanged Bushing Oil Pad (long) braided cotton, for 54090 .. |
| 59456 | 9870 | Looper Thread Guide Nut Washer..... |
| 59534 | 8964 | Tension (under thread) Spring..... |
| 59535 | 8964 | " (upper thread) Spring..... |
| 59537 | 8964 | " (under thread) Spring Bushing (large)..... |
| 59537 | 8964 | Tension (upper thread) Spring Bushing (large)..... |
| 59538 | 8964 | Tension (under thread) Spring Bushing (small)..... |
| 59538 | 8964 | Tension (upper thread) Spring Bushing (small)..... |
| 59539 | --- | Tension (under thread) Screw Stud 50326c with 51570c..... |
| 59539 | --- | Tension (upper thread) Screw Stud 50326c with 51570c..... |

| NO. | PLATE | NAME |
|-------|-------|--|
| 60656 | 8952 | Bench Stand Hinge for 79611..... |
| 60884 | 8985 | Machine Base Oil Pipe Plug for 54358 and 68224..... |
| 61047 | 8911 | Presser Bar Lifting Bracket with 460c and 1872..... |
| 61075 | 8911 | Presser Bar Lifting Lever Connecting Stud..... |
| 64255 | 8911 | Arm Rock Shaft Crank (front) with 453c, for 54079..... |
| 64259 | 9874 | Balance Wheel with two 430c..... |
| 64268 | 8904 | Crank Connecting Rod Ball Screw Stud Nut Washer..... |
| 64315 | 9870 | Looper Driving Shaft and Feed Lifting Eccentric Bracket Oil Hole Plug for 54368..... |
| 64319 | 9872 | Needle Bar (hollow) for 54493..... |
| 64320 | 8961 | " " Bushing (upper)..... |
| 64330 | 9873 | Presser Bar with 25303..... |
| 64331 | 8911 | " " Bushing (lower)..... |
| 64351 | 9870 | Thread (under) Nipper Cam with 465c, for 54384 and 68111..... |
| 64355 | 9871 | Thread (under) Take-up Thread Guard (brass) for 54384 and 68111..... |
| 64356 | 9871 | Thread (under) Take-up Thread Guard Steady Pin..... |
| 64362 | 8996 | Presser Bar Lifting Lever, obsolete..... |
| 64386 | 8901 | Arm Rock Shaft Bushing (back)..... |
| 64388 | 8901 | " " " " (intermediate). |
| 64508 | 8902 | " Rotary Shaft Bushing (intermediate) Oil Pad (long) braided cotton, for 54089 |
| 64805 | 8985 | Arm Rotary Shaft Bushing (intermediate) Oil Pad (short) braided cotton, for 54089 |
| 64805 | 8985 | Arm Rotary Shaft Flanged Bushing Oil Pad (short) braided cotton, for 54090 .. |
| 68001 | 9871 | Tension (under thread) Plate..... |
| 68002 | 9874 | " (upper thread) Bracket..... |
| 68003 | 9874 | " " " Releasing Shaft.. |
| 68004 | 9871 | Thread (under) Eyelet (back)..... |
| 68005 | 9871 | " " " (front)..... |
| 68006 | 9871 | " (upper) Eyelet..... |
| 68007 | 9871 | " " Take-up for 68009..... |
| 68008 | 9871 | " " " Plate for 68009. |
| 68009 | --- | Thread (upper) Take-up complete, Nos. 1449b, 68007, 68008 and 68164..... |
| 68010 | 9875 | Throat Plate, for $\frac{3}{32}$ in. to $\frac{9}{64}$ in. gauges, for 54489..... |

| NO. | PLATE | NAME |
|--------|-------|--|
| 68015 | — | Looper (intermediate) 54492 with 229d, 1302d and 54491..... |
| 68022 | — | Feed Rocking Frame 54026 with 21506, 54020, 54023, 54488 and 57225..... |
| 68026 | — | Presser Foot Plate for 68027..... |
| 68027 | 9877 | Presser Foot (hinged) guide on bottom, complete, for $\frac{3}{32}$ in. to $\frac{9}{64}$ in. gauges, Nos. 26276, 46087 and 68026..... |
| 68072 | 9875 | Feed Dog, 14 teeth (19 teeth to the inch) for 68073..... |
| 68073 | 9875 | Throat Plate, for $\frac{5}{32}$ in. to $\frac{3}{16}$ in. gauges, for 68072, for 147-30 Machine..... |
| 68083 | 9871 | Looper Thread Guide..... |
| 68086 | — | Presser Foot Needle Plate for 68088..... |
| 68087 | — | “ “ Plate for 68088..... |
| 68088 | 9877 | Presser Foot (hinged) complete, for $\frac{9}{64}$ in. to $\frac{3}{8}$ in. gauges, for overall work, Nos. 11184, 54495, 54498, 68086, 68087, 68160, 68161 and two each 665w and 51065c..... |
| *68109 | — | Arm, upper and lower (solid) with 948d and 54034, for 147-31 Machine..... |
| *68110 | 9880 | Arm Rotary Shaft for 68111..... |

NOTE: When No. 68110 is required for repairs, the Looper Driving Shaft and Feed Lifting Eccentric must be returned to the factory to be adjusted to the new part.

| | | |
|-------|------|--|
| 68111 | — | Arm Rotary Shaft 68110 with 640d, 54008, 54088, 54113, 54383, 64351 and 64355, for 147-31 Machine..... |
| 68160 | 9877 | Presser Foot Needle Plate Spring (left) for 54499 and 68088..... |
| 68161 | 9877 | Presser Foot Needle Plate Spring (right) for 54499 and 68088..... |
| 68162 | 9876 | Feed Dog, 15 teeth (10 teeth to the inch) for 68163..... |
| 68163 | 9876 | Throat Plate, for $\frac{1}{8}$ in. to $\frac{3}{16}$ in. gauges, for 68162, for 147-31 Machine..... |
| 68164 | 9871 | Thread (upper) Take-up Plate Spring for 68009..... |
| 68165 | 9871 | Thread (under) Take-up Staple..... |
| 68184 | 9873 | Presser Bar Lifting Lever Extension..... |
| 68191 | — | Cloth Plate Slide (right) for 68192..... |
| 68192 | — | Cloth Plate Slide (right) complete for 68267, Nos. 38419, 68191 and two 725J..... |
| 68202 | — | Presser Foot Plate for 68203..... |

| NO. | PLATE | NAME |
|---------|-------|--|
| 68203 | 9877 | Presser Foot (hinged) complete, for $\frac{3}{32}$ in. to $\frac{3}{16}$ in. gauges, for 147-30 Machine, Nos. 26276, 46087 and 68202..... |
| 68208 | 9873 | Presser Bar Lifting Lever..... |
| 68222 | 9879 | Belt Guard with two screws 1 in. No. 12..... |
| 68223 | 9879 | Machine Base for 68224..... |
| 68224 | — | Machine Base complete, Nos. 49123, 60884, 68223, three each 6055, 51072E and four each 948E and 57285..... |
| 68247 | — | Needle Guard, for $\frac{5}{32}$ in. to $\frac{3}{16}$ in. gauges between each needle..... |
| 68261 | — | Tension (upper thread) Releasing Shaft Spring..... |
| 68267 | — | Cloth Plate complete, for $\frac{3}{32}$ in. to $\frac{3}{16}$ in. gauges, for 68073, for 147-30 Machine and for $\frac{1}{8}$ in. to $\frac{3}{16}$ in. gauges, for 68163, for 147-31 Machine, Nos. 54011, 54013 and 68192..... |
| 79611 | — | Bench Stand with 5604, 9370, two 41538, three wood screws $1\frac{1}{4}$ in. No. 14, four 60656 and sixteen wood screws $\frac{5}{8}$ in. No. 7..... |
| 120341 | 8941 | Tweezers, curved (Accessories)..... |
| 120344 | 8941 | Oiler (copper plated) with 120345 (Accessories)..... |
| 120345 | 8941 | Oiler Spout, 5 in. long, for 120344..... |
| 120524 | 9878 | Lap Seam Feller on Shank..... |
| 120707 | 9878 | “ “ “ “ “ to allow for taking work out of folder and finishing pocket seams..... |
| 120753 | — | Presser Foot Plate with Edge Folder, for 120754..... |
| 120754 | 9877 | Presser Foot (hinged) with Edge Folder complete, for yoking, for $\frac{3}{32}$ in. to $\frac{3}{16}$ in. gauges, for 147-30 Machine, Nos. 26276, 46087 and 120753..... |
| 126247 | 8952 | Bench Stand Flush Bolt for 41538..... |
| 126248 | 8952 | “ “ “ “ Plate for 41538.. |
| 126249 | 8980 | Treadle for 126252..... |
| 126250 | 8941 | “ Spring for 126252..... |
| 126251 | 8980 | “ Stand for 126252..... |
| 126252 | 8980 | Treadle complete, Nos. 4882, 126249 to 126251 and two wood screws 1 in. No. 16..... |
| 128215 | 9872 | Needle Clamp with three 1498F, for 54493..... |
| 200383c | 8985 | Thread Unwinder Spool Rest Rod Set Screw for 202490..... |

From the Library of the Department of Textiles, University of Toronto

NUMERICAL LIST OF PARTS

| NO. | PLATE | NAME |
|---------|-------|---|
| 201018c | 8985 | Thread Unwinder Spool Rest Set Screw for 225395..... |
| 201696j | 9872 | Thread Unwinder Thread Guide Lock Nut for 225378..... |
| 202490 | 8997 | Thread Unwinder Spool Stand with 200383c, for 225378..... |
| 225378 | 8997 | Thread Unwinder complete, Nos. 201696j, 202490, 225388, 225392, three each 225395, six 225391 and three wood screws $\frac{7}{8}$ in. No. 12..... |
| 225388 | 8997 | Thread Unwinder Spool Rest Rod for 225378..... |
| 225390 | 8996 | Thread Unwinder Thread Cone Holder, for inverted cones..... |
| 225391 | 8997 | Thread Unwinder Thread Guide for 225378 |
| 225392 | 8997 | “ “ “ “ Rod with 208E and 225393, for 225378..... |
| 225393 | 9872 | Thread Unwinder Thread Guide Rod Washer for 225392..... |
| 225395 | 8997 | Thread Unwinder Spool Rest (for two spools) with 201018c for 225378..... |

Genuine Singer Needles and their Containers are marked with the Company's Trade Mark "SIMANCO." 1

Needles in Containers marked "For Singer Machines" are not Singer made needles. 2

**ILLUSTRATIONS OF PARTS
FOR
MACHINES
Nos. 147-30 and 147-31**

PLATE 8901—FULL SIZE

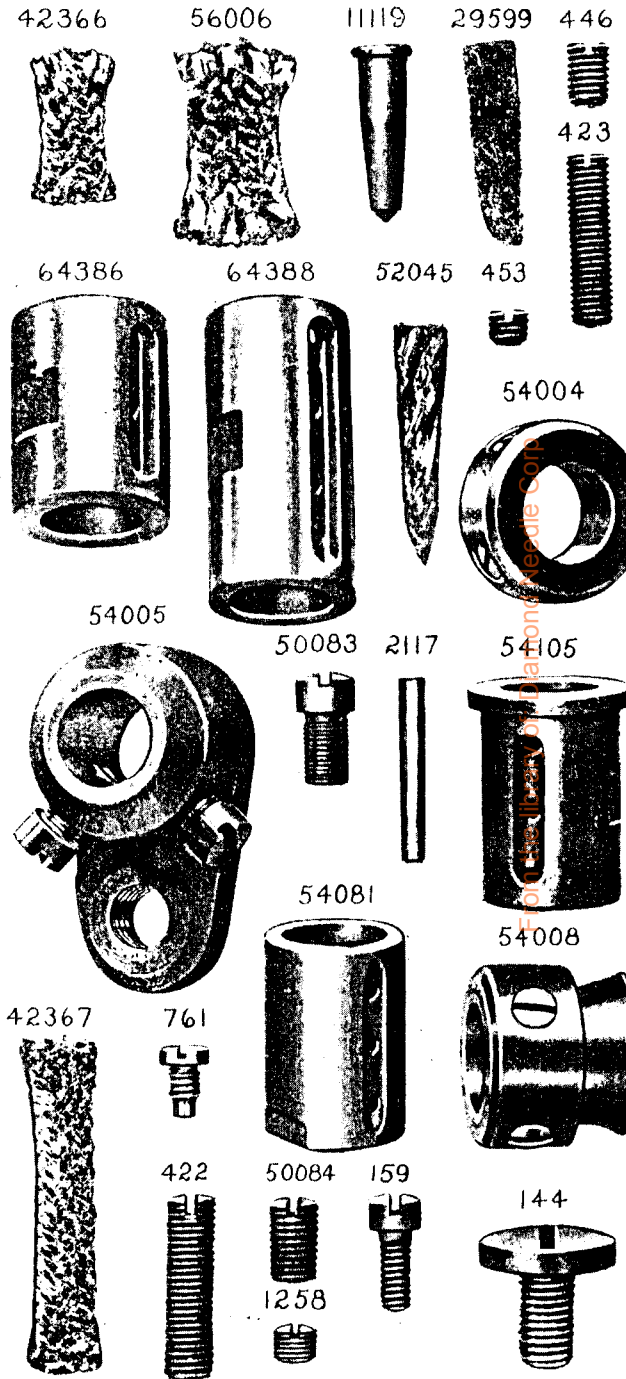
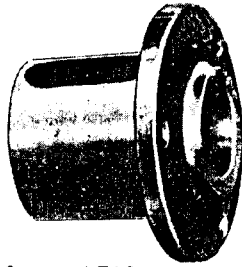
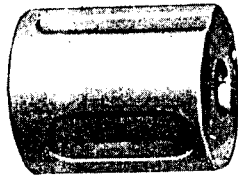


PLATE 8902—ONE-HALF SIZE

54002

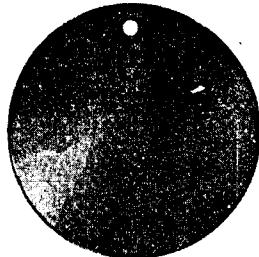
54007

54009



54017 64508 58039

15196

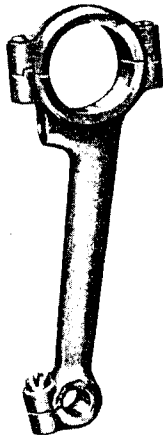
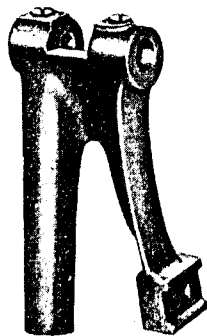


54012



54019

54111



54020

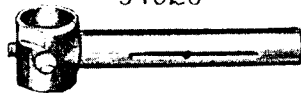


PLATE 8904—FULL SIZE

49013

286

54010

430



50473

1011



38419

725

1235



50069

1516

64268

896

1057



54897

57225

21506

457

54218



6575

443

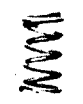
7071



50429

61171

1103



157

21332



934

From the library of: Diamond Needle Corp

PLATE 8911—FULL SIZE

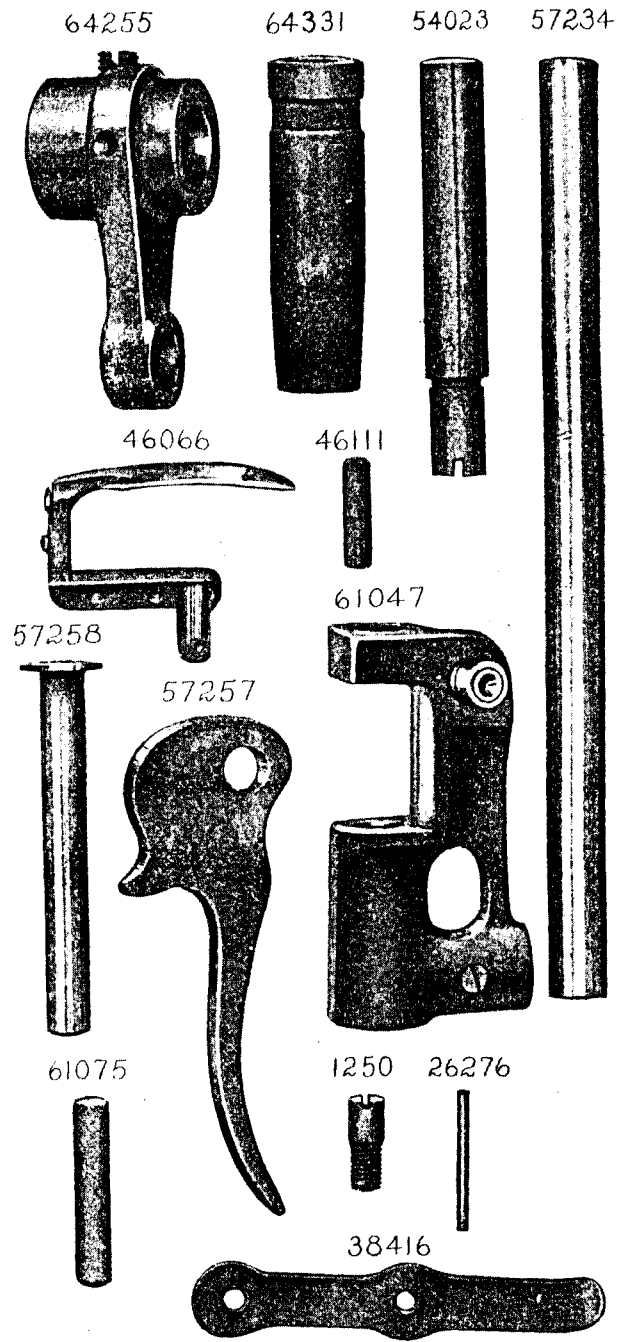


PLATE 8941—ONE-HALF SIZE

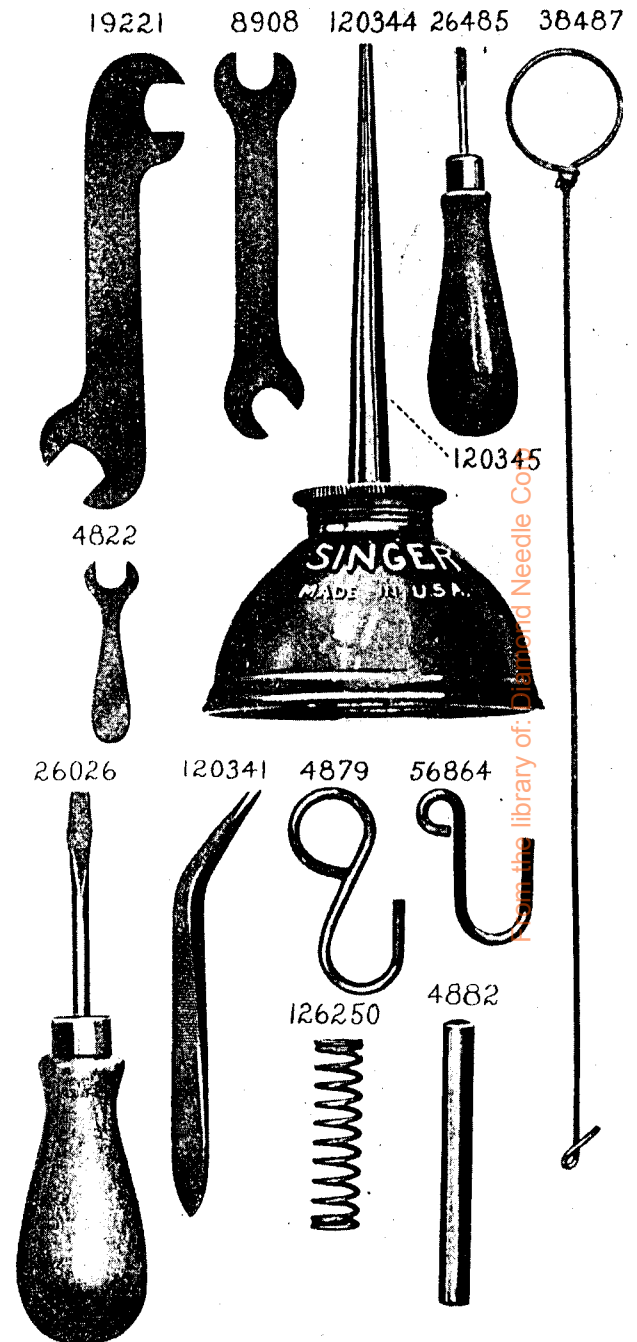


PLATE 8952—FULL SIZE

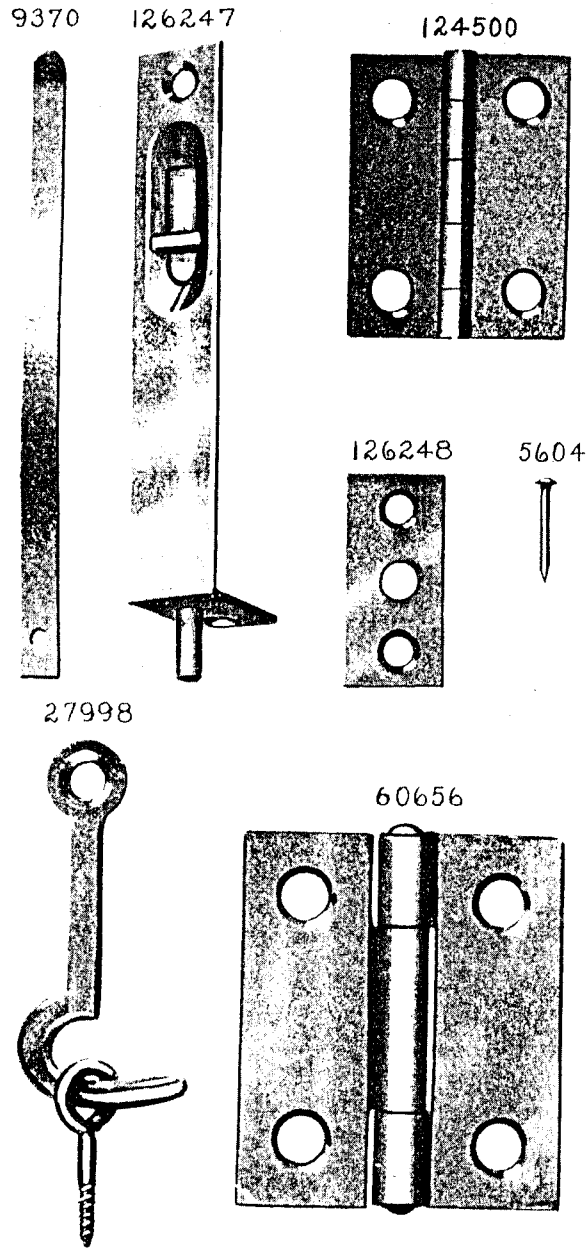


PLATE 8958—FULL SIZE

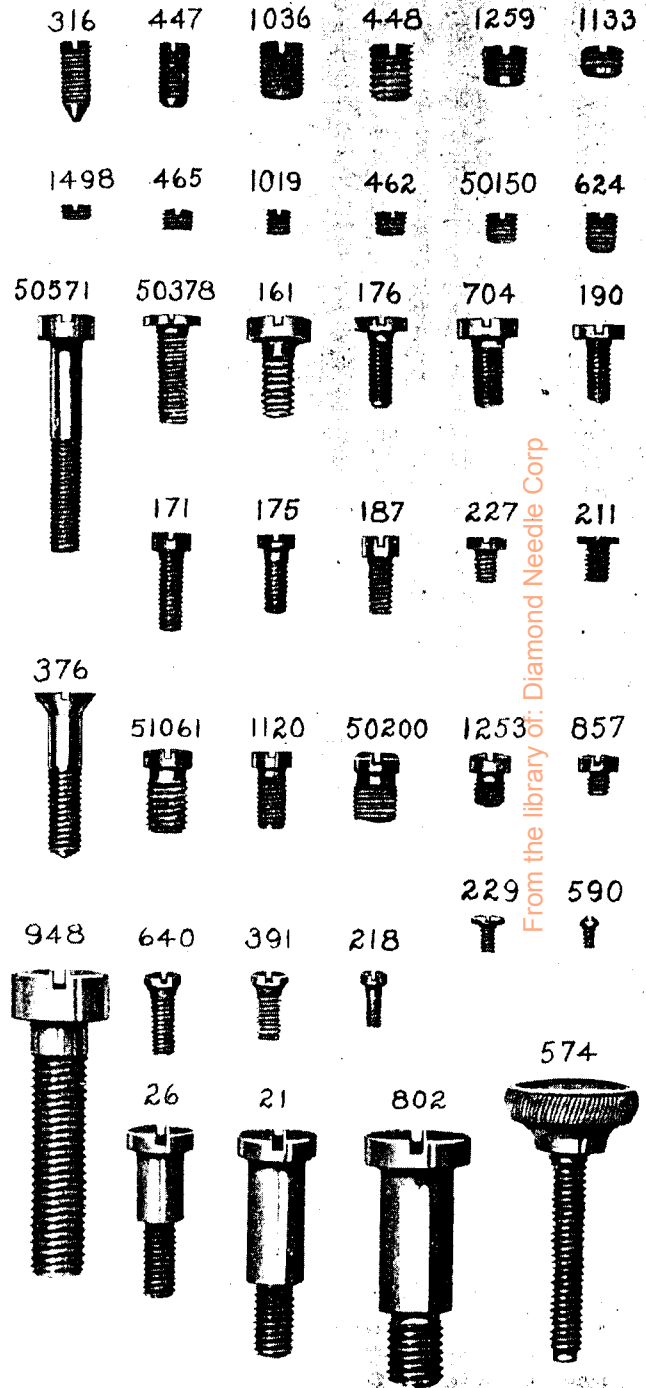


PLATE 8961—FULL SIZE

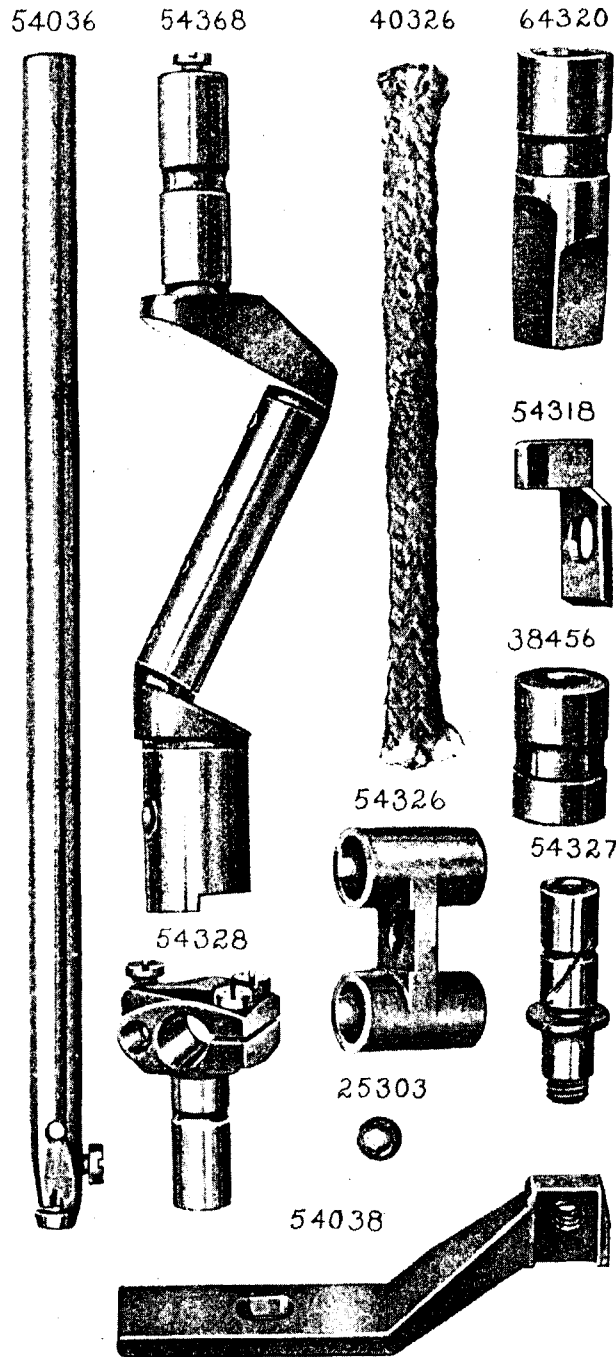


PLATE 8964—FULL SIZE

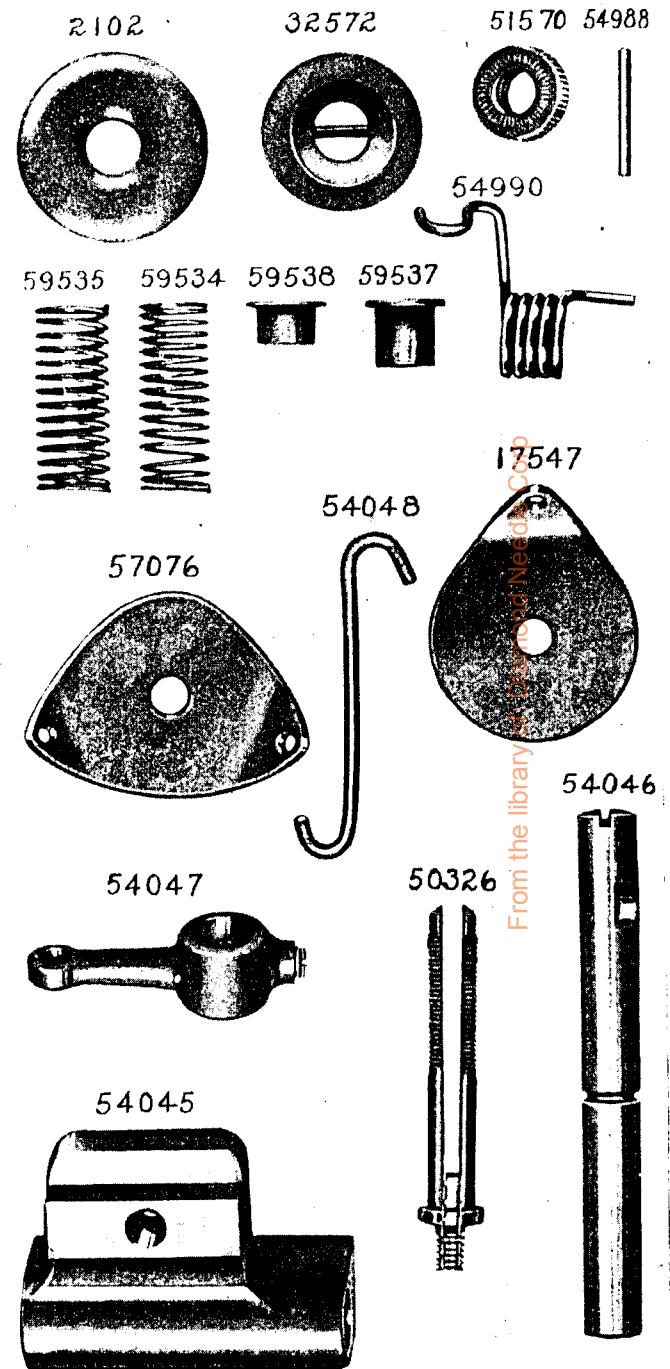


PLATE 8980—ONE-FOURTH SIZE

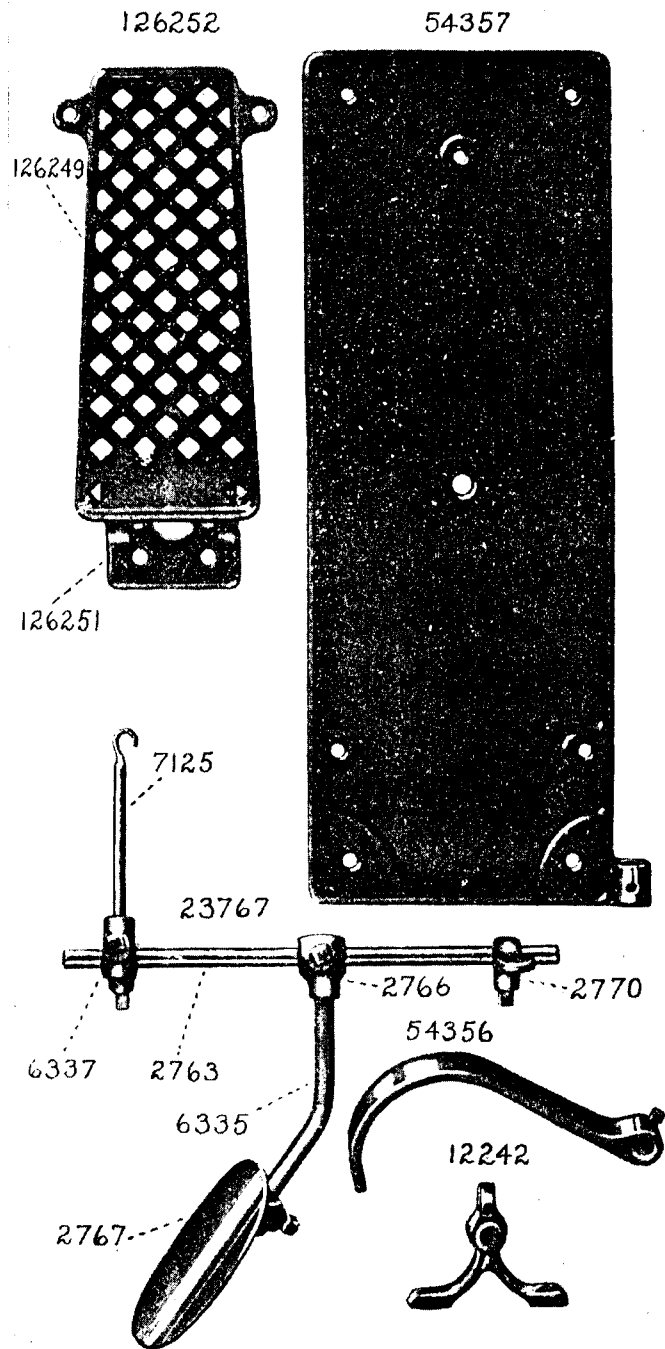
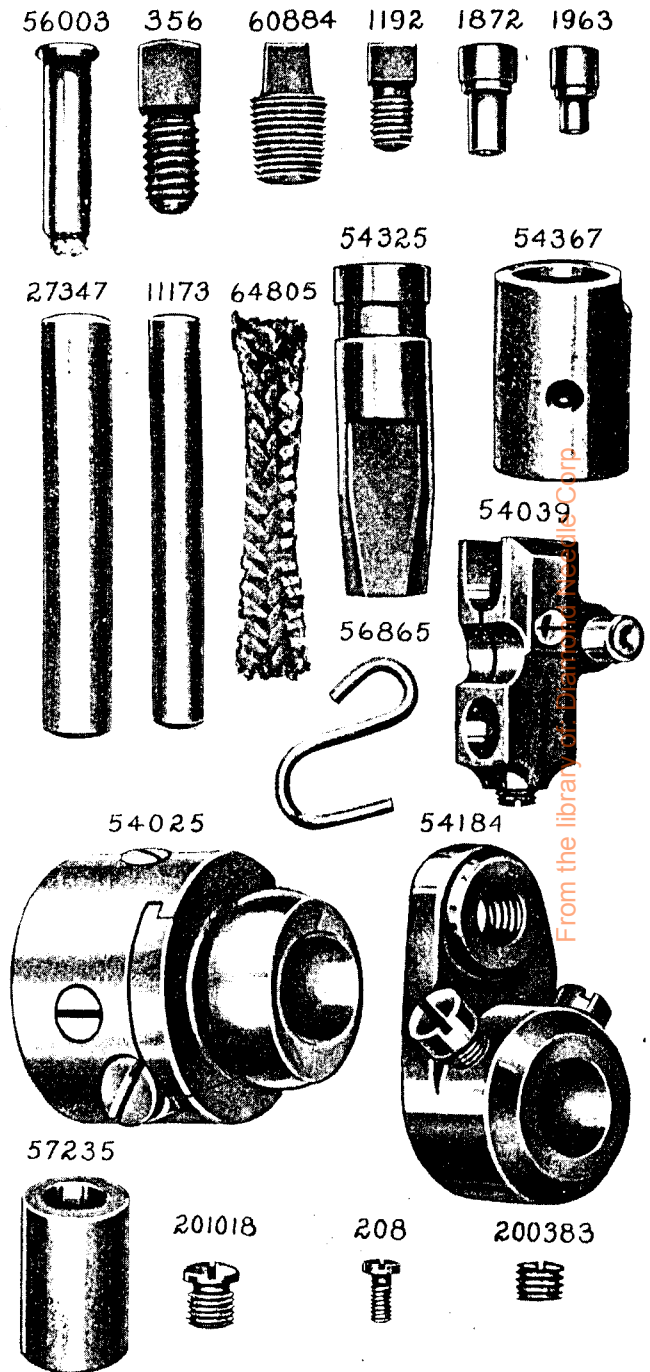


PLATE 8985—FULL SIZE



From the library of the National Archives and Records Administration

PLATE 8996—ONE-HALF SIZE

64362 54245 54070 49123

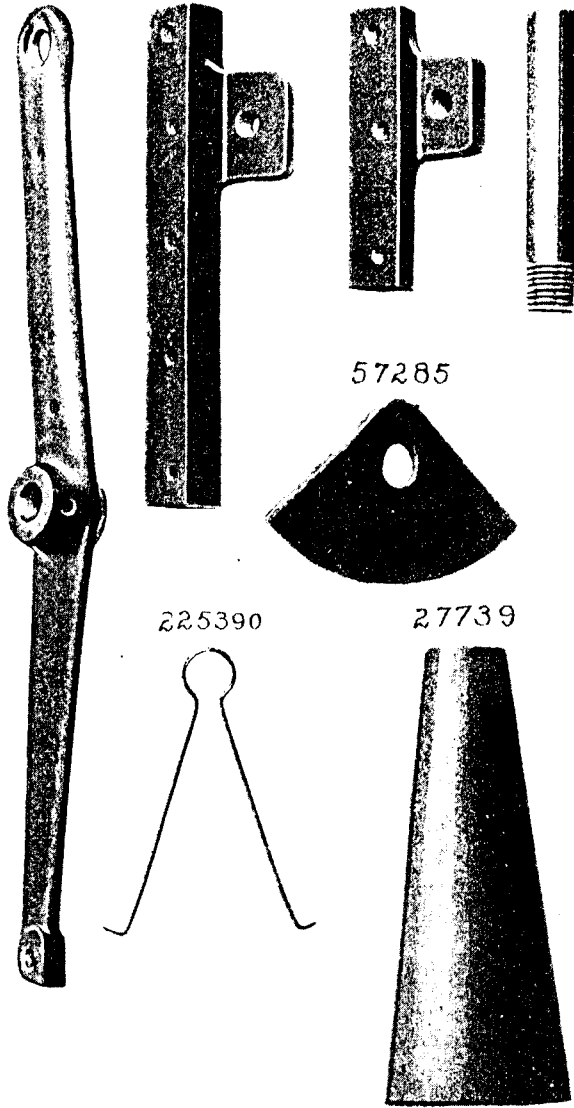
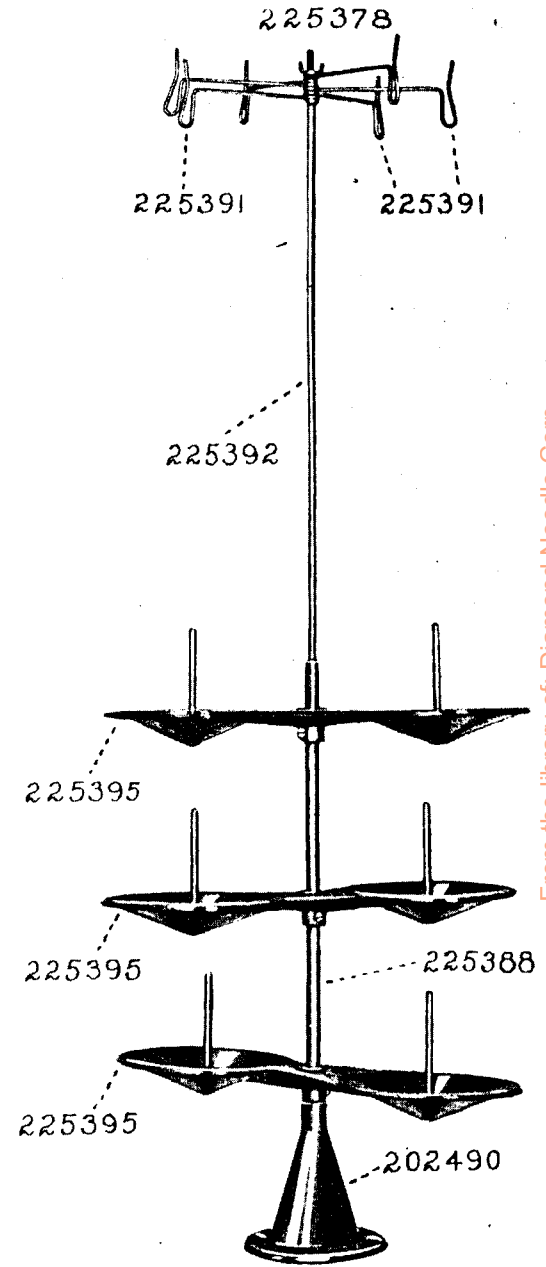


PLATE 8997—ONE-SIXTH SIZE



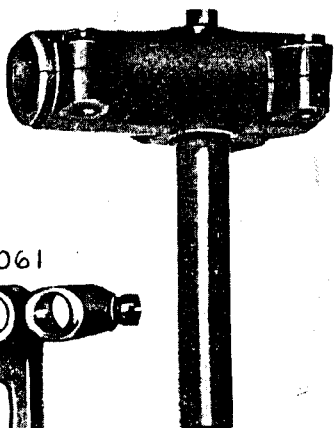
From the library of: Diamond Needle Corp

PLATE 9869—FULL SIZE

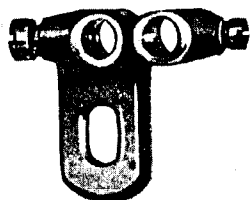
54228



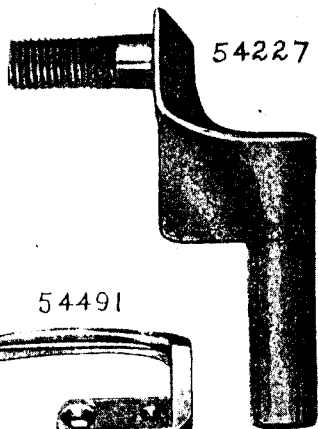
54230



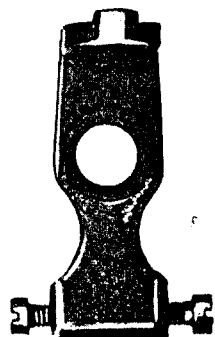
54061



54227



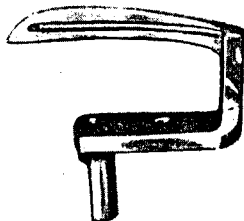
54027



54491



54492



54490

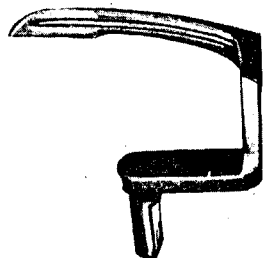
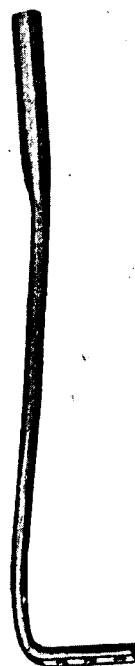


PLATE 9870—FULL SIZE

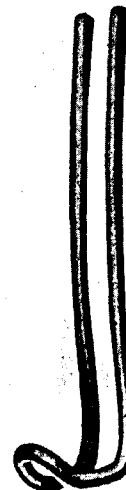
54500



54043



54381



54042



54044



54242



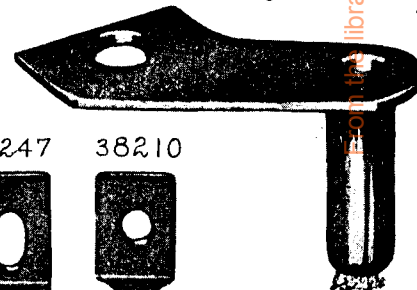
24292



38211



54110



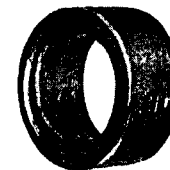
46247



38210



64351



49092



64315



59456



From the library of: Diamond Needle Corp.

PLATE 9871—FULL SIZE

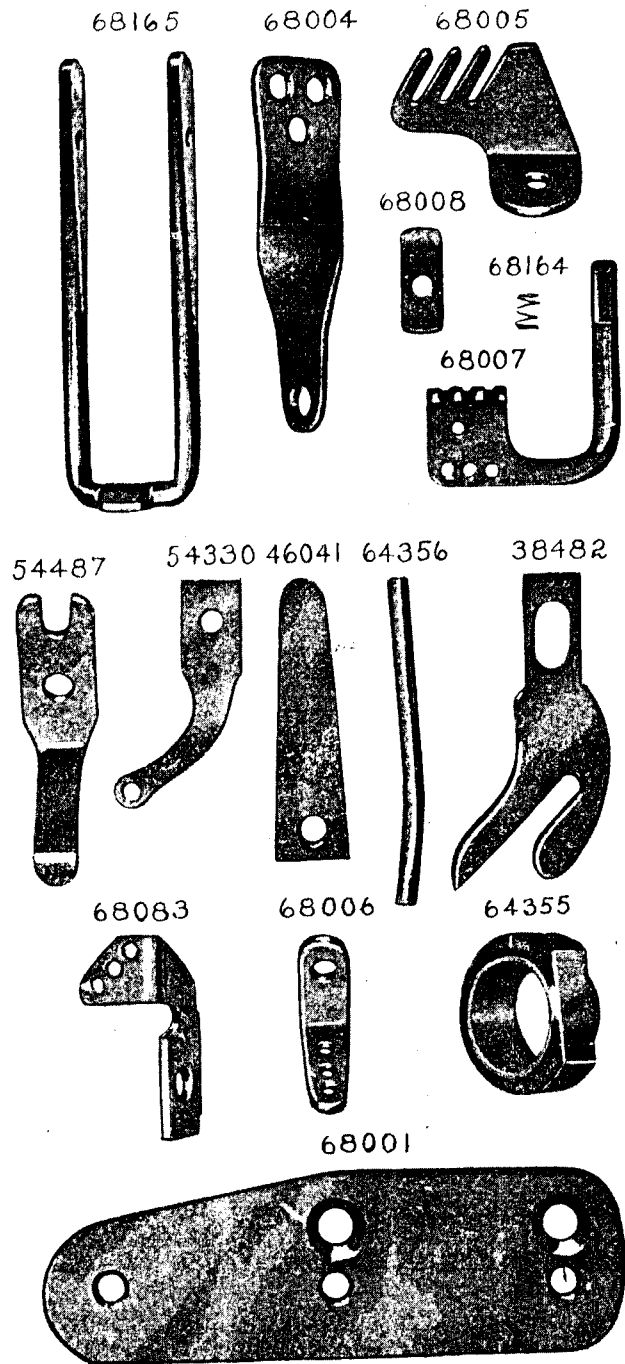
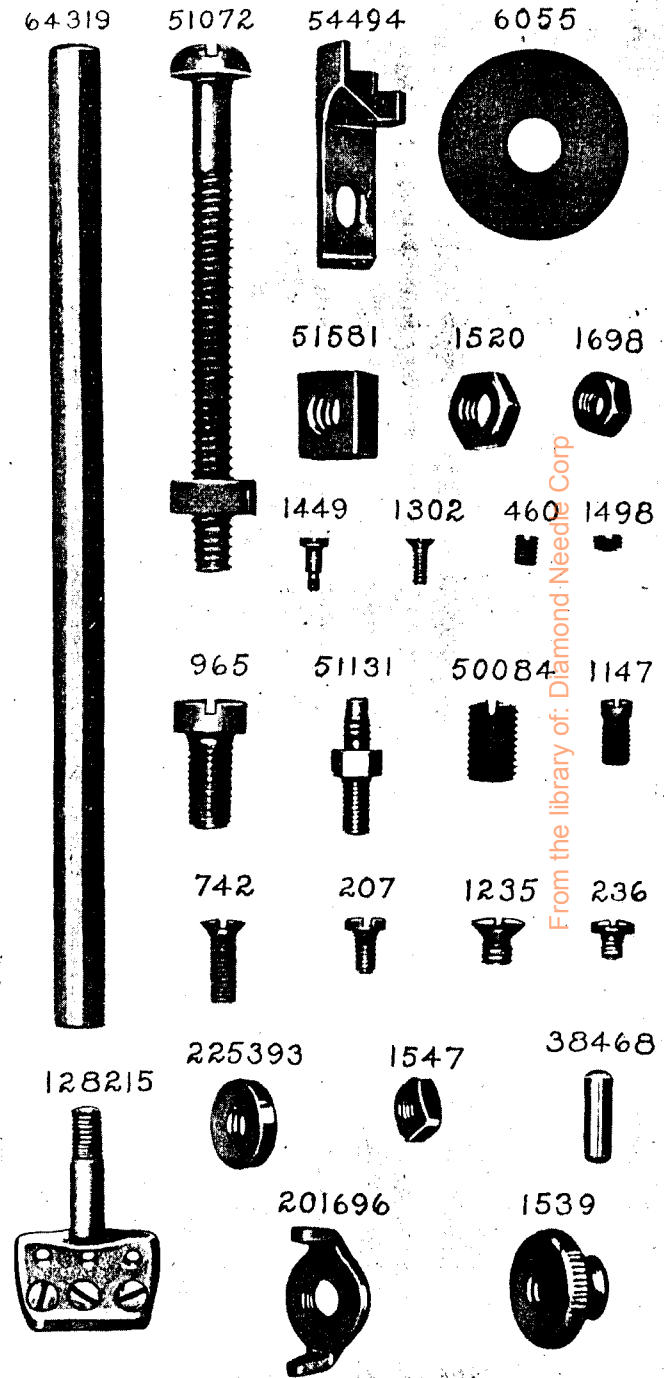


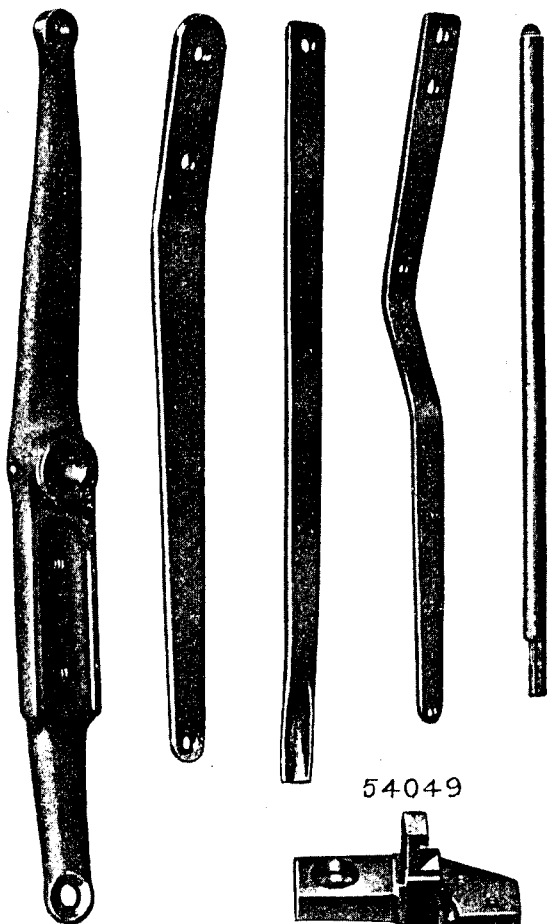
PLATE 9872—FULL SIZE



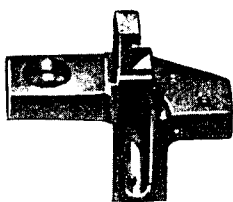
From the library of: Diamond Needs Corp

PLATE 9873--ONE-HALF SIZE

68208 68184 54040 54103 64330



54049



54026

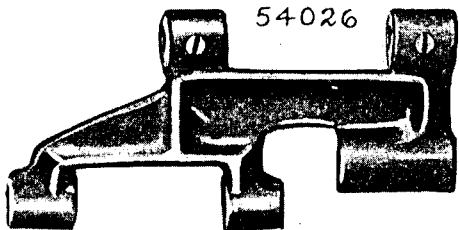
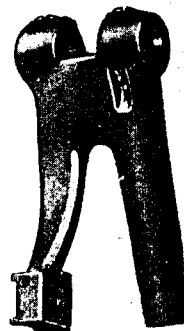
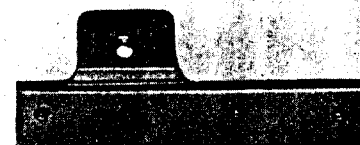


PLATE 9874--ONE-HALF SIZE

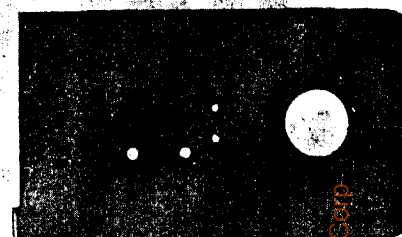
54488



68002



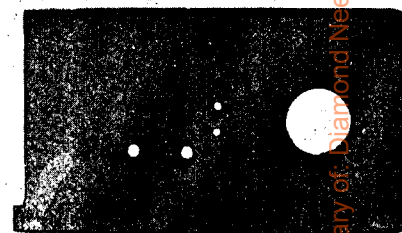
54055



68003



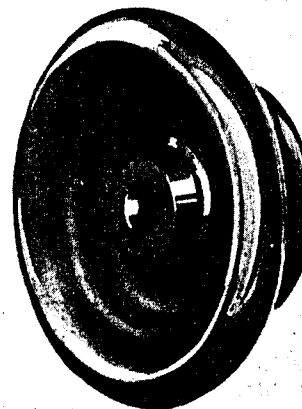
54057



54486

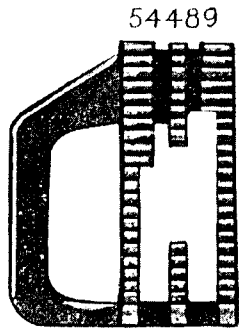


64259



From the library of Diamond Needle Corp

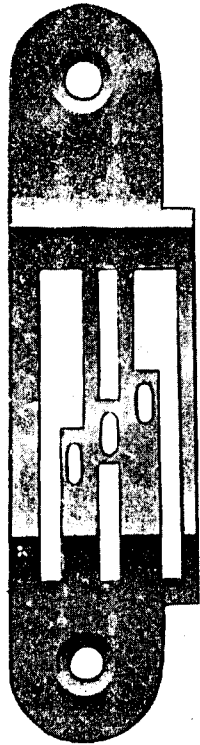
PLATE 9875—FULL SIZE



68010



68073



68072

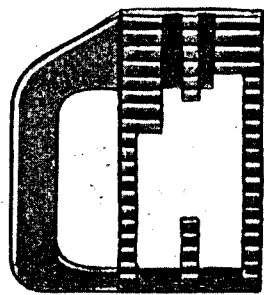
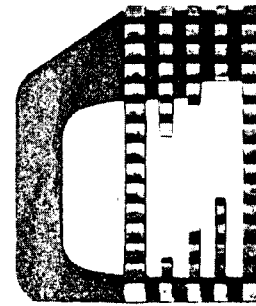


PLATE 9876—FULL SIZE

68162



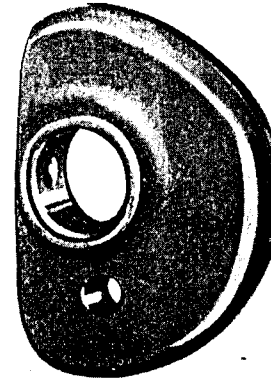
68163



54229



38475



54080

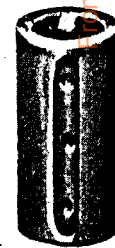
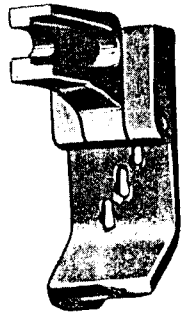


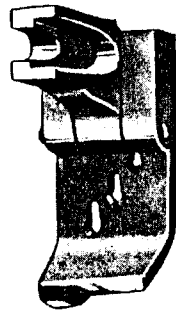
Image Library of the National Archives and Records Administration

PLATE 9877—FULL SIZE

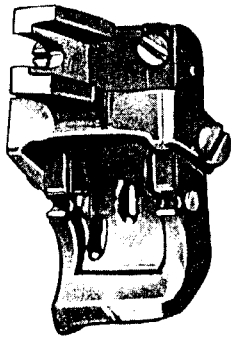
68027



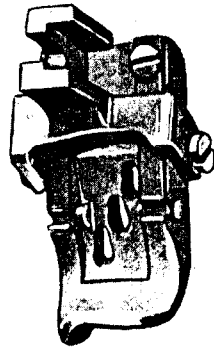
68203



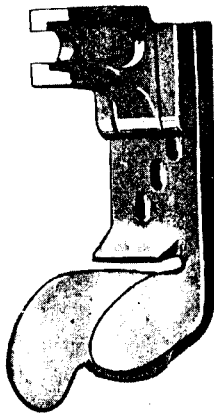
68088



54499



120754



68160



68161



26276



11184



665

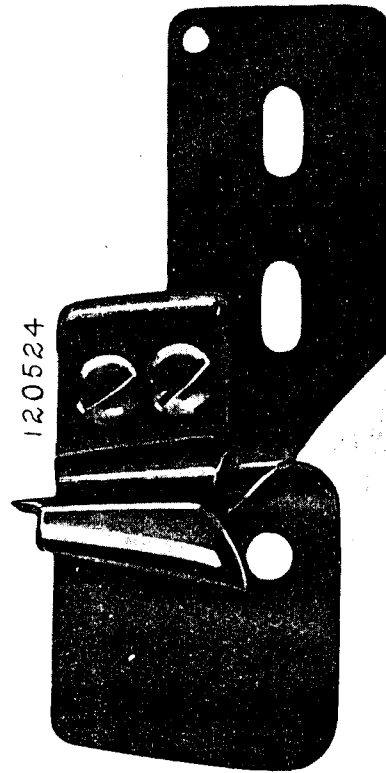


51065

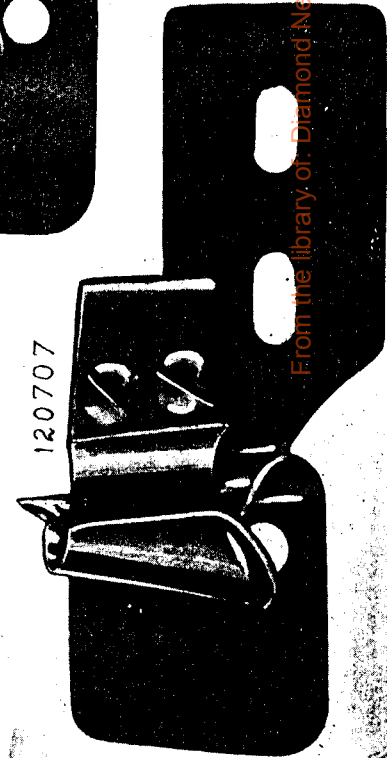


PLATE 9878—FULL SIZE

120524

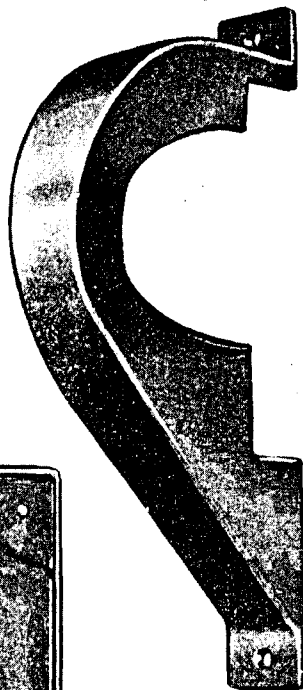


120707

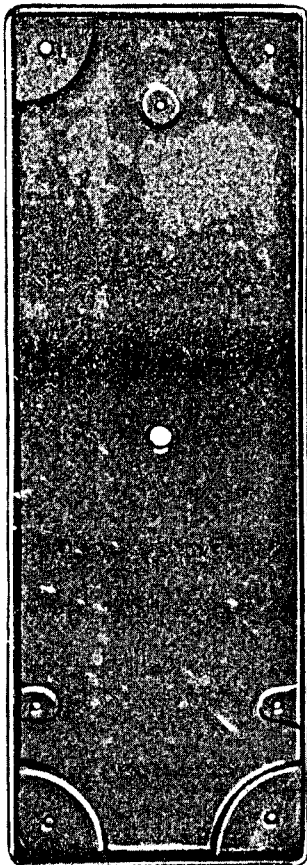


From the library of Diamond Needle Corp

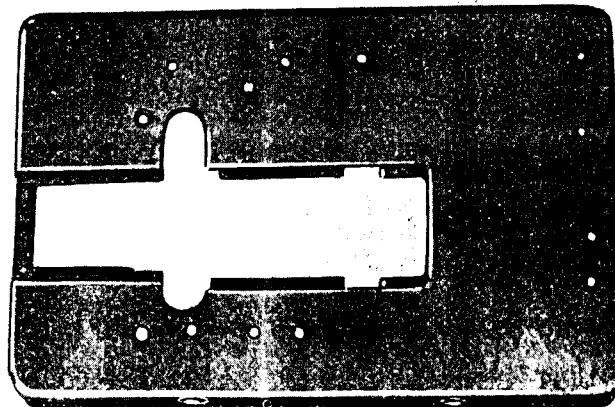
68222



68223



54011

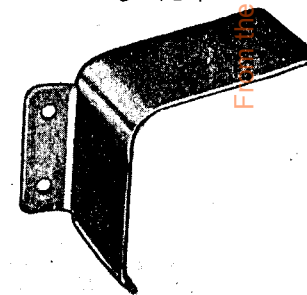


54006

68110



54104



From the library of: Diamond Needle Corp